

THE AAO

FORUM FOR OSTEOPATHIC THOUGHT

JOURNAL



A Publication of the American Academy of Osteopathy

TRADITION SHAPES THE FUTURE • VOLUME 13 NUMBER 3 FALL 2003

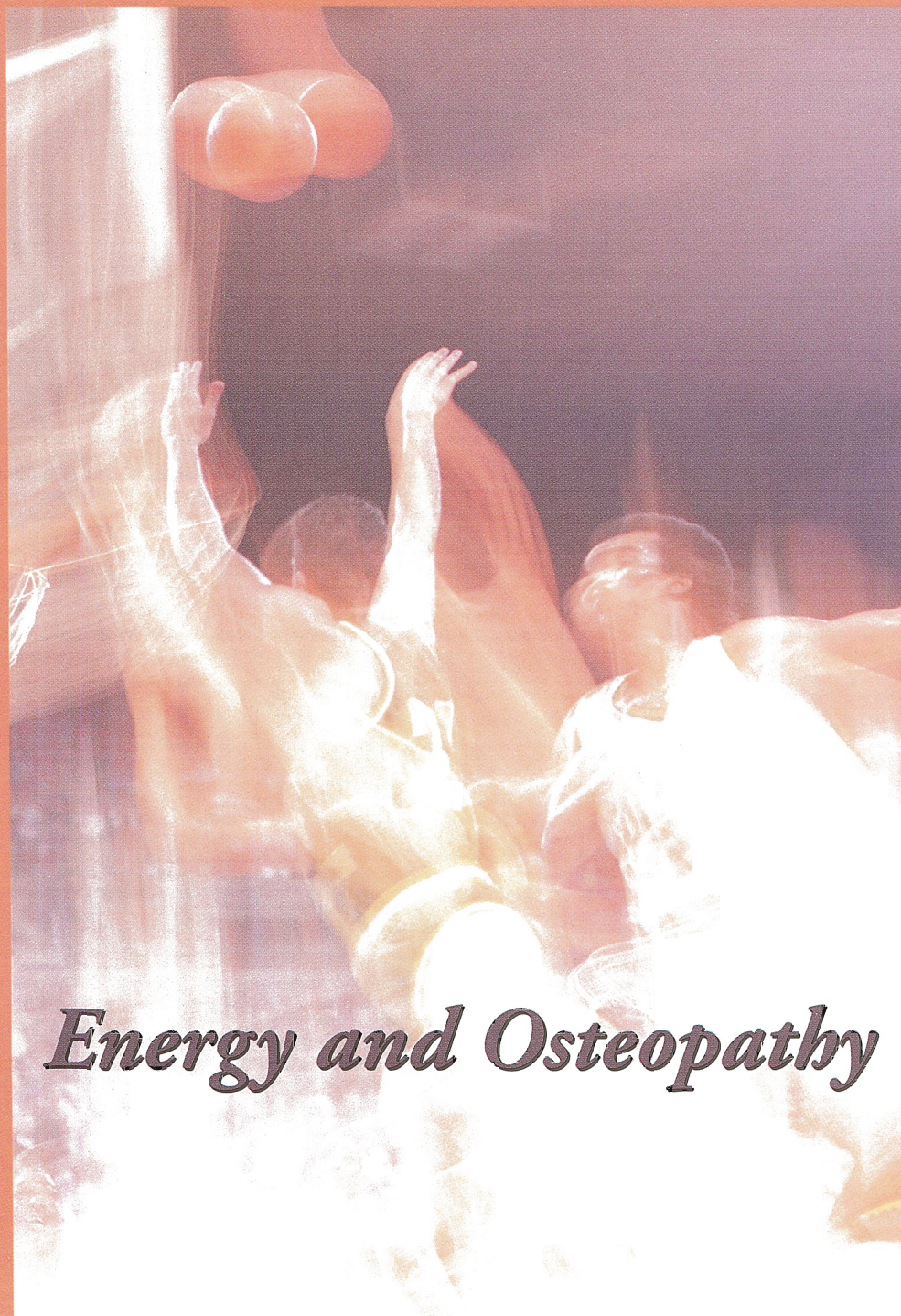

Energy and Osteopathy

Instructions to Authors

The American Academy of Osteopathy (AAO) Journal is a peer-reviewed publication for disseminating information on the science and art of osteopathic manipulative medicine. It is directed toward osteopathic physicians, students, interns and residents and particularly toward those physicians with a special interest in osteopathic manipulative treatment.

The AAO Journal welcomes contributions in the following categories:

Original Contributions

Clinical or applied research, or basic science research related to clinical practice.

Case Reports

Unusual clinical presentations, newly recognized situations or rarely reported features.

Clinical Practice

Articles about practical applications for general practitioners or specialists.

Special Communications

Items related to the art of practice, such as poems, essays and stories.

Letters to the Editor

Comments on articles published in *The AAO Journal* or new information on clinical topics. Letters must be signed by the author(s). No letters will be published anonymously, or under pseudonyms or pen names.

Professional News of promotions, awards, appointments and other similar professional activities.

Book Reviews

Reviews of publications related to osteopathic manipulative medicine and to manipulative medicine in general.

Note

Contributions are accepted from members of the AOA, faculty members in osteopathic medical colleges, osteopathic residents and interns and students of osteopathic colleges. Contributions by others are accepted on an individual basis.

Submission

Submit all papers to Anthony G. Chila, DO, FAO, Editor-in-Chief, Ohio University, College of Osteopathic Medicine (OUCOM), Grosvenor Hall, Athens, OH 45701.

Editorial Review

Papers submitted to *The AAO Journal* may be submitted for review by the Editorial Board. Notification of acceptance or rejection usually is given within three months after receipt of the paper; publication follows as soon as possible thereafter, depending upon the backlog of papers. Some papers may be rejected because of duplication of subject matter or the need to establish priorities on the use of limited space.

Requirements for manuscript submission:

Manuscript

1. Type all text, references and tabular material using upper and lower case, double-spaced with one-inch margins. Number all pages consecutively.
2. Submit original plus three copies. Retain one copy for your files.
3. Check that all references, tables and figures are cited in the text and in numerical order.
4. Include a cover letter that gives the author's full name and address, telephone number, institution from which work initiated and academic title or position.
5. Manuscripts must be published with the correct name(s) of the author(s). No manuscripts will be published anonymously, or under pseudonyms or pen names.
6. For human or animal experimental investigations, include proof that the project was approved by an appropriate institutional review board, or when no such board is in place, that the manner in which informed consent was obtained from human subjects.
7. Describe the basic study design; define all statistical methods used; list measurement instruments, methods, and tools used for independent and dependent variables.
8. In the "Materials and Methods" section, identify all interventions that are used which do not comply with approved or standard usage.

Computer Disks

We encourage and welcome computer disks containing the material submitted in hard copy form. Though we prefer Macintosh 3-

1/2" disks, MS-DOS formats using either 3-1/2" or 5-1/4" discs are equally acceptable.

Abstract

Provide a 150-word abstract that summarizes the main points of the paper and its conclusions.

Illustrations

1. Be sure that illustrations submitted are clearly labeled.
2. Photos should be submitted as 5" x 7" glossy black and white prints with high contrast. On the back of each, clearly indicate the top of the photo. Use a photocopy to indicate the placement of arrows and other markers on the photos. If color is necessary, submit clearly labeled 35 mm slides with the tops marked on the frames. All illustrations will be returned to the authors of published manuscripts.
3. Include a caption for each figure.

Permissions

Obtain written permission from the publisher and author to use previously published illustrations and submit these letters with the manuscript. You also must obtain written permission from patients to use their photos if there is a possibility that they might be identified. In the case of children, permission must be obtained from a parent or guardian.

References

1. References are required for all material derived from the work of others. Cite all references in numerical order in the text. If there are references used as general source material, but from which no specific information was taken, list them in alphabetical order following the numbered journals.
2. For journals, include the names of all authors, complete title of the article, name of the journal, volume number, date and inclusive page numbers. For books, include the name(s) of the editor(s), name and location of publisher and year of publication. Give page numbers for exact quotations.

Editorial Processing

All accepted articles are subject to copy editing. Authors are responsible for all statements, including changes made by the manuscript editor. No material may be reprinted from *The AAO Journal* without the written permission of the editor and the author(s).

AMERICAN ACADEMY OF OSTEOPATHY

Dennis J. Dowling, DO, FAAO President
Stephen D. Blood, DO, FAAO ... President Elect
Stephen J. Noone, CAE Executive Director

AAO PUBLICATIONS COMMITTEE

Raymond J. Hruby, DO, FAAO Chairperson
Denise K. Burns, DO
Stephen M. Davidson, DO
Eileen L. DiGiovanna, DO, FAAO
Eric J. Dolgin, DO
Stefan L.J. Hagopian, DO
Hollis H. King, DO, PhD, FAAO
John McPartland, DO
Paul R. Rennie, DO
Mark E. Rosen, DO

Ex-officio Members:

Myron C. Beal, DO, FAAO Yearbook Editor
Anthony G. Chila, DO, FAAO Journal Editor

THE AAO JOURNAL

Anthony G. Chila, DO, FAAO Editor-in-Chief
Stephen J. Noone, CAE Supervising Editor
Diana L. Finley, CMP Managing Editor

The AAO Journal is the official quarterly publication of the American Academy of Osteopathy, 3500 DePauw Blvd., Suite 1080, Indianapolis, Indiana, 46268. Phone: 317-879-1881; FAX: (317) 879-0563; e-mail snoone@academyofosteopathy.org; AAO Website: <http://www.academyofosteopathy.org>

Third-class postage paid at Carmel, IN. Postmaster: Send address changes to American Academy of Osteopathy 3500 DePauw Blvd., Suite 1080, Indianapolis, IN., 46268.

The AAO Journal is not itself responsible for statements made by any contributor. Although all advertising is expected to conform to ethical medical standards, acceptance does not imply endorsement by this journal.

Opinions expressed in *The AAO Journal* are those of authors or speakers and do not necessarily reflect viewpoints of the editors or official policy of the American Academy of Osteopathy or the institutions with which the authors are affiliated, unless specified.

A PEER-REVIEWED JOURNAL

The Mission of the American Academy of Osteopathy is to teach, advocate, and research the science, art and philosophy of osteopathic medicine, emphasizing the integration of osteopathic principles, practices and manipulative treatment in patient care.

In this Issue:

AAO Calendar of Courses	4
View from the Pyramids – <i>Anthony G. Chila, DO, FAAO</i>	5
Contributors	6
Component Societies' CME Calendar	7
Letters to the Editor	8
<i>Walter C. Ehrenfeuchter, DO, FAAO</i>	
<i>Robert T. Kellam, DO</i>	
From the Archives	10
History of Osteopathy in France	12
<i>Bernard Barillon, DO, MRO, PtAOC</i>	
The Osteopathic Education	14
<i>Alistair C. Moresi, Bachelor of Applied Science (Osteopathy)</i>	
“The Energy cyst”: Its Ramifications and Use in Osteopathic Manipulative Management	16
<i>Richard C. MacDonald, DO</i>	
Dynamic Strain-Vector Release: An Energetic Approach to OMT	19
<i>Jan T. Hendryx, DO and Richard L. O'Brien, DO</i>	
Facilitated Oscillatory Release – a Method of Dynamic Assessment and Treatment of Somatic Dysfunction	30
<i>Zachary J. Comeaux DO, FAAO</i>	
Book Reviews	37
Elsewhere in Print	39

Advertising Rates for the AAO Journal
An Official Publication
of The American Academy of Osteopathy
The AOA and AOA affiliate organizations and members of the Academy are entitled to a 20% discount on advertising in this Journal.

Call: The American Academy of Osteopathy
(317) 879-1881 for more information.

Subscriptions: \$60.00 per year (USA)
\$78.00 per year (foreign)

<u>Advertising Rates:</u>	<u>Size of AD:</u>
Full page \$600 placed (1) time	7 1/2 x 9 1/2
\$575 placed (2) times	
\$550 placed (4) times	
1/2 page \$400 placed (1) time	7 1/2 x 4 3/4
\$375 placed (2) times	
\$350 placed (4) times	
1/3 page \$300 placed (1) time	2 1/4 x 4 3/4
\$275 placed (1) times	
\$250 placed (4) times	
1/4 page \$200 placed (1) time	3 1/3 x 4 3/4
\$180 placed (2) times	
\$150 placed (4) times	
Professional Card: \$60	3 1/2 x 2
Classified: \$1.00 per word	

AAO Calendar of Events

OCTOBER 2003

- 11 One-day Course: OMT in Geriatrics
New Orleans, LA
- 12-16 AOA Convention; New Orleans, LA
- 25-26 Dr. Fulford's Basic Percussion Course;
Chicago, IL

NOVEMBER 2003

- 7-9 Prolotherapy - Below the Diaphragm
UNECOM, Biddeford, ME
- 15-16 AOBNMM Examinations in Indy

DECEMBER 2003

- 1 AOBNMM Apr '04 candidates' deadline
for case histories
- 5-7 Visceral Manipulation/Urogenital
NSUCOM, Ft. Lauderdale, FL

2004

JANUARY

- 23-25 *Diagnosis of Muscle Imbalance & Exercise
Prescription (The Greenman Protocol)*
AZCOM, Glendale, AZ

FEBRUARY

- 13-16 *Osteopathic Treatment of Headache*; Honolulu, HI

MARCH

- 15-17 *Osteopathic Approach to Gastroenterology
(Visceral Technique)*, Colorado Springs, CO
- 18-21 *2004 Annual Convocation*, Colorado Springs, CO

APRIL

- 24-25 *Dr. Fulford's Advanced Percussion Technique*
CCOM, Downers Grove, IL

MAY

- 14-16 *Prolotherapy: Above the Diaphragm*
UNECOM, Biddeford, ME

JUNE

- 4-6 *Clinical Jones Strain-Counterstrain I for the Spine
and Rib Cage*; Indianapolis, IN

JULY

- 23-25 *Still Technique (Applications of a Rediscovered
Technique)*, WVSOM, Lewisburg, WV

AUGUST

- 19-22 *14th Annual OMT Update*; Buena Vista, FL

SEPTEMBER

- 30 - Oct 2 *Emotional Diagnosis and Release (Barral
Approach)*; San Diego, CA

OCTOBER

- 3- 5 *Unlocking the Cranial Sutures (The Face)*
San Diego, CA

NOVEMBER

- 6 *Modifying Delivery of OMT in an Allopathic
Environment*; San Francisco, CA
- 7-11 AOA / AAO Convention; San Francisco, CA
- 12-14 *Prolotherapy: Below the Diaphragm*
UNECOM, Biddeford, ME

DECEMBER

- 4-5 *Facilitated Positional Release*
NUSOM; Ft. Lauderdale, FL

Sutherland Cranial Teaching Foundation

COURSES:

October 17-20, 2003

PRM Research/SCTF Continuing Studies
(In cooperation with The Cranial Academy)
Course Directors: Michael Burruano, DO, and
Anthony Chila, DO, FAAO
Indian Lakes Resort, Bloomingdale, IL
Contact: The Cranial Academy
Phone: 317/594-0411

March 21-23, 2004

2004 SCTF Intermediate Course – the Face
(immediately following the AAO Convocation)
The Broadmoor Hotel, Colorado Springs, CO
Course Director: Doug Vick, DO
Faculty: SCTF Board
Prerequisites: 2 Basic Cranial Course,
one being SCTF and 3 years of Clinical Practice
Contact: Judy Staser
Phone: 817/926-7705

These programs anticipate being approved
for AOA Category 1-A CME credit
pending approval by the AOA CCME

Visit our website at: www.sctf.com
and add your name to our mailing list

Polarization, Triangulation, then...?

In the United States during the 19th century, various heterodox medical systems existed. Among these were osteopathy, chiropractic, homeopathy, naturopathy, eclectic medicine. The first two emerged as medical revitalization movements through the early years of the 20th century. The official position of biomedicine (allopathy) toward all such groups was characterized by relegation to cult status and the utilization of a variety of efforts to deny or restrict practice. The success of osteopathy in obtaining full practice rights during the first half of the 20th century was met first by overt allopathic resistance and then, as time has shown, a strategy of co-optation.

Polarization is defined as a sharp division into opposing factions. This situation became the norm for the relationship between allopathic and osteopathic philosophies during the first half of the 20th century. MD dominance, DO emergence and the secondary relegation or failure of other systems contributed to the clarity of this division.

Triangulation is defined as the establishing of the relative position of two or more points. The early years of osteopathic history in the United States were characterized by numerous examples of cross-fertilization of medical degrees (MDs acquiring DO degrees and DOs acquiring MD degrees). Cultural cross-fertilization also occurred (European contributions to the developing American system of osteopathy and, subsequently, American contributions to the developing European systems of osteopathy). John Martin Littlejohn was first a patient of Andrew Taylor Still, then a student and faculty member at the American School of Osteopathy. His continuing career in the United States saw the establishment of the American College of Osteopathic Medicine and Surgery in Illinois. Following his return to England in 1913, he founded the British School of Osteopathy in 1917. Allopathic resistance to Littlejohn's effort largely paralleled the osteopathic experience in the United States. It is from that time that the growth of osteopathic practice in Europe, limited by statute, can be traced. At this distant

time, it should be remembered that Doctor Still's original argument was for the utilization of the full scope of medical knowledge.

Now in the early years of the 21st century, there has been increasing interest in osteopathic practice by MD physicians in the United States and in Europe. In the case of European physicians, this has led to the establishment of the World Osteopathic Health Organization (WOHO). As an entity, this organization will be independent of all other international schools and registries. In February 2003, the European Register of Osteopathic Physicians (EROP) was established by two groups: German Society of Osteopathic Medicine (DGOM) and German-American Academy of Osteopathic Medicine (DAAO). In March 2003, a position paper was submitted which proposed **International Criteria for Admission to the World "Registry of Osteopathic Physicians"**. These criteria focus on unlimited license for medical practice as achieved by the American DO. In countries outside the USA, unlimited license to practice in the country of residence (MD) is coupled with a postgraduate training program in Manual Medicine/Osteopathic Medicine requiring at least 4 years to complete. In April 2003 the DGOM and DAAO were joined by the Swiss Society of Osteopathic Physicians (SAGOM). In October 2003, the WOHO will meet at Schlangenbad, near Wiesbaden, in Germany. This meeting will be held during the time of the 6th International Congress of the Verbandes der Osteopathen Deutschland e.V. (VOD). This Annual Congress is an established focus for numerous European limited license groups. An International Forum, **Development of Osteopathic Medicine in Europe**, will hear statements from many European countries. Representational views will be given by MD physicians whose pursuit of osteopathic training is postgraduate in nature, and limited license practitioners who have their own traditions of development of osteopathic practice. What will follow in the coming years?

Andrew G. Child D.O., F.A.O.

Contributors

Barillon, B (Translated from French by Debroux, J-J. History of Osteopathy in France. American osteopathic physicians are often curious about the origin and development of the osteopathic profession abroad. M. Barillon was a member of the first class of European physicians and practitioners to participate in a course in Osteopathy in the Cranial Field conducted by Doctors Harold I. Magoun, Sr., Viola M. Frymann and Thomas F. Schooley. The location was Paris, France and the year was 1964. This recollection, originally prepared in 1990, some 25 years later, offers insight about the development of osteopathic thought in Europe prior to the 1964 teaching event. M. Barillon has been a long-time Affiliate Member of the Cranial Academy. J-J Debroux is an International Affiliate Member of the American Academy of Osteopathy. (p. 11)

Moresi, AC. The Osteopathic Education. It is reasonably well known by American osteopathic physicians that the British School of Osteopathy was founded by John Martin Littlejohn. The British influence in osteopathic training has extended throughout the Commonwealths and Dominions. The author is an Australian practitioner temporarily residing in the United States, and a Foreign Affiliate Member of the Cranial Academy. The value of this discussion lies in the fact it is based on the author's two-years experience with the teaching program of an American osteopathic medical school, TUCOM. The curriculum hours described were provided by the Registrar's Office of TUCOM and were accurate for the period of time specified. Subsequent changes have occurred. (p. 14)

MacDonald, RC. "The Energy Cyst": Its ramifications and use in Osteopathic Manipulative Management. The author is a past president of the American Academy of Osteopathy (1978-79). This discussion seeks to explain his understanding and use of a concept developed by John E. Upledger, DO, FAAO during the years of his (Upledger's) faculty affiliation with MSUCOM. This concept was given the name "Energy Cyst" by Elmer Green, PhD during a workshop at the Menninger Clinic. Examples are given for methods of location of the "Energy Cyst" and its application to gallbladder dysfunction. (p. 16)

Hendryx, JT and O'Brien, RL. Dynamic Strain-Vector Release: An Energetic Approach to OMT. The authors offer an extensive review of the contributions of thought which have influenced the understanding of energy and its disruption in the development of dysfunction. The reviews given provide an excellent resource for

understanding the differentiations of various energetic approaches to diagnosis, treatment and healing. In explaining their concept, they propose a modification of the familiar Somatic Dysfunction acronym TART, adding: **S (Strain) T (Tissue texture changes) A (Asymmetry of motion) R (Restricted range of motion) T (Tenderness).** (p. 19)

Comeaux, ZJ. Facilitated Oscillatory Release: A method of dynamic assessment and treatment of Somatic Dysfunction. This paper demonstrates the author's continuing refinement of his premises about the body's own rhythmic neural coding process. Tissue participation in wave mechanics is the basis of Facilitated Oscillatory Release (FOR). Viewed in the aspect of the uniqueness and individuality of patients, the principles of FOR may be individually expressed by the physician's preferred technical method(s). Comeaux is also the author of *Robert Fulford, DO and the Philosopher Physician (Eastland Press, 2002).* (p. 30)

Regular Features

Dig On. Due to the number of inclusions in this issue, this column is deferred and will resume in the next issue of *AAOJ*.

From the Archives. THEY WENT TO PARIS. A momentous event is described in detail. The Sutherland Cranial Teaching Foundation (SCTF) presented the first course in Osteopathy in the Cranial Field at Paris, France in 1964. The circumstances leading to the preparation for and delivery of this course demonstrate a strong motivation to overcome diversity in nationality and education, complicated by difficulty with language. As explained here, unification was achieved by exceptional fellowship in a common purpose. (p. 10)

Elsewhere in Print. Bunkan, BH, Opjordsmoen, S, Moen, O, Ljunggren, AE, Friis, S. **Palpation of Skeletal Muscles: A Psychometric Evaluation of the Muscular Items of the Comprehensive Body Examination.** The authors, in a comprehensive Medline search for "muscular consistency" and "palpation" were unable to find evidence of any psychometrically based dimensions of muscular consistency. Their development of four subscales with good psychometric properties is based on their work with Comprehensive Body Examination. Descriptors of tissue texture characteristics are utilized extensively in osteopathic clinical practice. A careful reading of this paper offers insight for seeking and establishing credible terminology in palpatory studies. (p. 39)

Component Societies' CME Calendar

and other Osteopathic Affiliated Organizations

October 4

Outcome-Based Osteopathy
Arizona Academy of Osteopathy
Poco Diablo Resort
Sedona, AZ
Hours: 8 Category 1A anticipated
Contact: William Devine, DO
623/572-3350

October 17-20

*Research Symposium/SCTF
Continuing Studies Program*
Indian Lakes Resort
Bloomington, IL
Hours: 25 Category 1A anticipated
The Cranial Academy
Contact: The Cranial Academy
317/594-0411

January 17-19, 2004

Basic Course Level 2
NSU/COM
Fort Lauderdale, FL
Hours: 24 Category 1A anticipated
The Cranial Academy
Contact: The Cranial Academy
317/594-0411

January 21-24

*15th Osteopathic Winter Seminar
and National Clinical Update*
Tradewinds Resort
St. Pete Beach, FL
Hours: 27 Category 1A anticipated
Pinellas County
Osteopathic Medical Society
Contact: Dr. Kenneth Webster
Phone: 717/581-9069 or
866/254-8798

February 6-8

TOMA Midwinter Conference
Omni Mandalay Hotel
Irving, TX
Texas Osteopathic Medical Assn.
Contact: TOMA
(512) 708-8662

February 18-22

*Midwinter Basic Course in Osteopathy
in the Cranial Field*
Tampa Palms Golf Resort
Tampa, FL
Hours: 40 Category 1A anticipated
The Cranial Academy
Contact: The Cranial Academy
317/594-0411

March 21-23

The FACE (an intermediate course)
Sutherland Cranial Teaching
Foundation
Colorado Springs
Contact: Judy Staser
817/926-7705

April 21-25

82nd Annual Convention
Wyndham Buttes Resort
Tempe, AZ
Hours: 38 Category 1A anticipated
Arizona Osteopathic Medical Assn
Contact: AOMA
602/266-6699

May 14-16

*Crash Recovery the Long Road Home:
Treating Victims of Motor Vehicle
Accidents and Brain Injuries*
Philadelphia College
of Osteopathic Medicine
Hours: 16 Category 1A anticipated
The Cranial Academy
Contact: The Cranial Academy
317/594-0411

June 19-23

*Basic Course in Osteopathy
in the Cranial Field*
Doubletree Columbia River Complex
Portland, OR
Hours: 40 Category 1A anticipated
The Cranial Academy
Contact: The Cranial Academy
317/594-0411

June 9-13

TOMA Annual Conference
Opryland Hotel
Grapevine, TX
Texas Osteopathic Medical Assn.
Contact: TOMA
(512) 708-8662

June 20-23

*Experiencing Osteopathy: An
Introduction to Continuum
Movement*
Doubletree Columbia River Complex
Portland, OR
Hours: 24 Category 1A anticipated
The Cranial Academy
Contact: The Cranial Academy
317/594-0411

June 27-29

*Biodynamic Approach
to the Fluid Body*
Doubletree Columbia River Complex
Portland, OR
Hours: 16 Category 1A anticipated
The Cranial Academy
Contact: The Cranial Academy
317/594-0411

Letters to the Editor

Dear Dr. Chila:

I read with interest Dr. Robert Kellam's letter on the use of OMT in Herpes Zoster and the Prevention of Post-Herpetic Neuralgia. It reminded me of an event during my OMM residency (1980-81). It seemed every journal coming my way had an article on the management of post-herpetic neuralgia. Despite this plethora of articles, I realized I had never seen a case. When I looked into the literature on incidence, it led me to believe that this was a common and devastating complication.

With this background I undertook an informal poll of the four full-time faculty members in the OMM Department at PCOM and three part-time faculty as well. With over 300 practice years of experience for the group, none of these doctors had ever seen a case of post-herpetic neuralgia develop in a patient that they treated with manipulation during the course of the acute infection. To be sure they had been consulted on treating patients who developed post-herpetic neuralgia while under another physician's care, but not one patient could be recalled who developed this complication while under osteopathic care.

Sure sounds like a subject for a multi-center outcomes trial to me.

Sincerely,

Walter C. Ehrenfeuchter, DO, FAAO
301 City Avenue, Suite 240
Bala Cynwyd, PA 19004
Telephone: 610/660-5220
Fax: 610/660-5290



Dear Dr. Chila

Please allow me to submit this letter regarding the management of Bell's Palsy with the use of manipulative therapy as the sole treatment for this condition. I feel quite confident that many osteopathic physicians have treated Bell's Palsy with manipulation and achieved very satisfactory results, but because it is so infrequently seen the results of their success is probably not well known. If there are osteopathic physicians who have had success in treating this condition, they should document their case histories and the results obtained. Hopefully, my letter will stimulate some discussions and interest in using manipulation to treat this malady.

OMT in the Treatment of Bell's Palsy

The incidence of Bell's Palsy is about 23 per 100,000 annually.¹ In my 38 years of practice. I have treated 12 patients, all of whom received osteopathic manipulative therapy as the sole method of treatment. Each patient that had been seen within the first 24 hours of onset recovered completely, all within a period of 3 weeks.

Bell's Palsy, some times referred to as Idiopathic Facial Paralysis is characterized by a sudden onset (12 to 48 hours) of facial paralysis. In a full blown case, the patient will exhibit drooping of the corner of the mouth on the side of involvement, tearing of the affected eye, inability to smile symmetrically, whistle, wink with the affected eye, wrinkle the forehead or close the eye on the affected side of the face. In a mild situation, the symptoms might go unnoticed. A brief history and physical examination is imperative to rule out

other causes of facial paralysis such as parotid gland tumors, Lyme disease, acoustic neuromas, cholesteatomas, Temporal bone fractures or other obvious pathological problems.

According to Adams¹ fully 80 percent of the patients recover within a few weeks to 2 months,¹ however I would like to think that all patients would fully recover if the condition is treated as soon as possible with manipulative therapy. While the etiology of Bell's Palsy is uncertain, the condition sometimes appears in the wake of an upper respiratory infection or other viral infection. Many times it will follow a chill to the face or neck area from air conditioners, fans or open car windows. Recent literature points to the strong possibility that the Herpes Simplex Virus (HSV) is the responsible etiological factor. Even so, in my mind it is doubtful that the Herpes Simplex Virus would be present if the vascularity of the facial nerve had not been compromised.

While the current therapy employed is the use of corticosteroids and anti viral agents such as Acyclovir and Valtrex, I personally would opt to employ osteopathic manipulative therapy as the primary modality in treating Bell's Palsy. Utilizing my osteopathic education, I became convinced many years ago that the Bell's Palsy was an ischemic neuronitis secondary to arteriolar constriction caused by an autonomic nervous disturbance, initiated or maintained by somatic dysfunctions found in the cervical and/or dorsal regions of the spine. Somatic dysfunctions in these regions can very easily and subtly have a profound effect upon the sympathetic nervous system through the sympathetic ganglia causing a

vasomotor shutdown, resulting in compromise of the blood supply to the nerve. On that premise, I long ago chose to treat my Bell's Palsy patients with manipulative therapy.

All of my patients, with the exception of one, were severe cases with full-blown symptoms. The one exception was a middle aged female admitted to the hospital by an ER physician with the diagnosis of a CVA. Soon after, I rendered a diagnosis of Bell's Palsy, administered OMT, and upon examination 24 hours later the patient found to be symptom free. This seemed truly remarkable to me. On another occasion I had the opportunity of treating a patient who had been under the care of another physician receiving only "eye checks" and "periodic checks" for two months with no noticeable improvement. He was treated with manipulation about 10 times over a period of a month and achieved full recovery. Recently I scanned the AAO yearbooks and found just two references to treating Bell's Palsy with manipulation, one by Perrin T. Wilson DO and the other by George Riley DO, both of whom were outstanding physicians of their time. To quote Perrin Wilson, DO, "In my 42 years of practice, I have seen a great many cases of Bell's Palsy. If these patients can have osteopathic therapy within a week to 10 days from the onset of paralysis, the results are excellent. The quickest cure I ever had was a case I got 24 hours after the paralysis. Osteopathic therapy applied every other day for 5 visits removed all traces of paralysis."²

My father, Lawrence J. Kellam DO years ago enjoyed similar success that I had in treating Bell's Palsy with osteopathic manipulative therapy and initially gave me the encouragement

to use OMT for this rarely seen but very annoying problem. From what I have heard and read the use of corticosteroids and antiviral agents are not as effective as we might have been led to believe; and that is all the more reason to think osteopathically.

It would be challenging to see how many cases of Bell's Palsy our profession could treat over a period of five years, utilizing osteopathic manipulative therapy, report their results to a investigative center. I think we, as a profession would be pleased with the results and so would our patients.

1. Principles of Neurology 6th Edition by Raymond D. Adams, Maurice Victor, Allan H. Bopper. p 1376. McGraw Hill.
2. 1962 AAO Yearbook. "Bell's Palsy". Perrin T. Wilson, DO. p 169-170.

Robert T. Kellam, DO
8503 Caracas Avenue
Orlando, FL 32825
timkeldo@aol.com



OOPS!
WE GOOFED!

Correction
Letter to the Editor
Spring issue; page 22

First Column: It should read "I personally believe that the patient and I are in agreement as being connected to something greater than the self or any particular *religion*."

Also, an editorial correction in the very last line of the letter [Thanks for *allowing* me to comment].

Our apologies to Dr. Miller.

AOA Convention 2003
AAO Program

***"Integration of Care:
From the specialist
to the primary care physician"***

Edward K. Goering, D.O.
Program Chairperson

October 13-15

Topics:

- Temporomandibular Joint Dysfunction:
An ENT Perspective*
- Treatment of the Temporomandibular Joint:
A Practical Solution*
- Northup Memorial Lecture*
- Female Pelvic Floor Anatomy:
A Laparoscopic Review*
- Treatment of the Female Pelvic Floor*
- Scoliosis and OMM*
- Evaluating Structural Effects
of Manual Medicine*
- Carpal Tunnel Syndrome & OMM*
- Low Back Pain & OMM*
- Male Sexual Dysfunction*
- Osteopathic Approach
to Male Sexual Dysfunction*
- Workshop on Treatment
of Male Sexual Dysfunction*
- Osteopathic Considerations
in End of Life Care*
- Cultural Differences in End of Life Care*
- Role of the Hospice in End of Life Care*
- End of Life Care – A Personal Reflection*
- Orthopedic and Osteopathic Evaluation
and Treatment of the Knee*
- Neuromuscular Evaluation and Treatment
of the Knee Utilizing Strain/Counterstrain*
- Hands-on Workshop
on Treatment of the Knee*

From the Archives

They Went to Paris

Cranial Academy *News Letter*, Volume 18, Number 2, December 1964
Reprinted with permission from The Cranial Academy

They went, they taught, they soared ...and “enthusiasm, encouragement, exhilaration” are only a few of the inadequate words to describe the reports, verbal and written, on the success of the course in cranial osteopathy conducted in Paris, France, by Drs. Harold I. Magoun, Sr., Viola M. Frymann, and Thomas F. Schooley.

Aside from the detailed report to the Cranial Academy Executive Board, Dr. Magoun would stress to the Academy membership “the fact that the class was outstanding because of three reasons: (1) The initiative, which sparked the preparation over a period of many months with study group meetings under Dr. Brookes’ coaching and Dr. Lung’s translation of *The Cranial Bowl* and the text; (2) the interest, which pervaded the classroom at all times, as manifested by the tape recordings, the photographing, the diagramming and the diligent application to master the work being given; and (3) the hospitality, which warmed all our hearts with so many thoughtful and unusual expressions and made the extracurricular activities memorable indeed.”

Further details of the above points are brought out in the following report, written for the *News Letter*, by Dr. Viola M. Frymann:

History was made on August 29th, 1964. At 8:30 am, Harold I. Magoun, DO welcomed nine students to the first European course in cranial osteopathy sponsored by the Sutherland Cranial Teaching Foundation

(SCTF). It was held in the spacious offices of Dr. René Quiguiner in Paris, France. The students included five doctors of medicine who practice in France, one doctor of medicine who also holds an osteopathic degree from the London College of Osteopathy and who practices in London, and three doctors of osteopathy who practice in various parts of England.

One of the latter, Denis Brookes, was responsible for the organization of this course, and the outstanding preparation of the French students. For several years he had devoted a weekend out of every month to studying with them the philosophy, theory and art of osteopathy. In 1962, he attended Dr. Magoun’s lecture at the British School of Osteopathy. As a result of this, he was inspired to take the introductory course in Kansas City in 1963. He returned to his French “study group” with the textbook, *Osteopathy in the Cranial Field*. This was translated, word for word, into French, and they began to study the theory of anatomy and physiology described therein. When the possibility of an SCTF course in Europe was presented to learn the technic and the practical application.

Dr. Brookes also served as the official interpreter on the numerous occasions when the limited French of the faculty was inadequate to the needs of either social or professional discourse.

Two of the Frenchmen were Viet-

namese, graduates of the University of Saigon. Their training in the art of acupuncture, which requires very fine discrimination in the palpation of the pulses, equipped them with a wonderful palpatory instrument for cranial, sacral, and other physiological rhythms of the body. One English DO holds a degree in anatomy and is a part-time assistant in the anatomy department of the University of Leeds.

This group of students of diverse nationalities and education, struggling with a foreign language, were united in the wonderful fellowship of a common purpose to deepen their understanding of osteopathy in general, to gain a practical knowledge of the cranial concept and the ability to use it. Their enthusiasm, their eagerness to understand every word and demonstration, their concern to preserve every lecture on tape and every technic on moving pictures and their thrill as the concept and its application unfolded before them was an unforgettable and stimulating experience. I feel sure I speak for the whole faculty – Harold Magoun, Thomas Schooley, and myself – when I say it has never been our privilege to teach such an enthusiastic, responsive, and receptive group of student as we met in Paris this year.

But no account of this experience would be complete without a mention of the fabulous hospitality extended to us. Each evening a different facet of French life was presented. On the first night, aboard the Bateau-

Mouches, we enjoyed an unusual and delectable repast as we glided gently up the Seine. The climax of this voyage was the sight of the Cathedral of Notre Dame, floodlit – gradually the lights were dimmed until its dark silhouette alone was visible against the night sky. Then the inner flow of light behind the rose window become visible through this colorfully stained glass. Eventually this also faded, giving place to a purple light, which bathed the towers and gradually spread all over the building. A hush fell upon the company at this ethereal spectacle.

Another right a truly oriental repast in the custom of the Vietnamese was provided. The visit to the Palace at Versailles on another evening was memorable, too.

But the climax of these social hours came on the last evening. The French doctors, assisted by their charming wives, had planned a banquet in the restaurant of the Eiffel Tower. Two hundred feet below lay Paris. The Seine reflected the lights above. L'Arc de Triomphe, floodlit in the distance, stood out in sharp contrast to the darkness around it. Within, the atmosphere was light and gay. And, then, at a prearranged moment, the lights were dimmed. A flaming baked Alaskan cake, inscribed with Happy Birthday and surmounted by nine pink candles, was placed on the table in celebration of my daughter's ninth birthday. The orchestra drew near to play their birthday greetings and everyone rose to toast her.

On the day after the course, we were taken on a lovely 260-miles journey to the Cathedral of Rheims; through the rolling hills, covered with the vineyards of the champagne country, to visit a champagne manufacturing plant and to enjoy a delightful dinner in the home of Dr. Mau at Pleurs. It was indeed a fitting conclusion, complete with fireworks in the garden, to an unforgettable experience, the birth of cranial osteopathy in France.

Three New books in AAO Bookstore

Silent Waves: Theory and Practice of Lymph Drainage Therapy

ISBN 0-9700530-5-3 • AAO Catalogue #PR1950

Price: \$65.00 + shipping/handling

Counterstrain and Exercise: An Integrated Approach

ISBN 0-9712758-0-7 • AAO Catalogue #PR2000

Price: \$69.95 + shipping/handling



Selected Writings of Paul E. Kimberly, DO

ISBN 0-9406681-6-5 • AAO Catalogue # WPCD04

Price \$49.95 + shipping/handling

Order Information:

- Silent Waves: Theory and Practice of Lymph Drainage Therapy*
@ \$65.00 plus \$8.00 shipping and handling
- Counterstrain and Exercise: An Integrated Approach*
@ \$69.95 plus \$2.00 shipping and handling
- Selected Writings of Paul E. Kimberly, DO*
@ \$49.95 plus \$7.00 shipping and handling

(NOTE: Please add \$1.00 for each additional book ordered.)

WRITE OR CALL FOR FOREIGN SHIPPING RATES

Total \$ amount of order: _____

Shipping Information:

Name _____

Street Address _____

(No P.O. Box #s)

City _____

State _____ Zip _____

Daytime Phone _____

Payment Information:

VISA MC CHECK

Card No. _____

Expiration Date _____

TO ORDER, MAIL TO:

American Academy of Osteopathy®
3500 DePauw Blvd., Suite 1080
Indianapolis, IN 46268

FAX TO:

317/879-0563

OR CALL:

Kelli Bowersox, Receptionist/Secretary®
American Academy of Osteopathy
Phone: 317/879-1881

E-mail:

kbowersox@academyofosteopathy.org

AAO accepts
checks/money orders
Visa or MasterCard

History of Osteopathy in France

Bernard Barillon, DO, MRO, PtAOC

(Translated from French by Jean-Jacques Debroux, DO, mSBO)

Perhaps the first individual to speak about osteopathy in France was an MD physician named Lavezarri. Doctor Lavezarri practiced in Nice and Paris. During the years of World War I, he knew a DO serving in the United States Army in France. This practitioner introduced Doctor Lavezarri to concepts of osteopathic practice. The time was 1917-1918: The United States had become a combatant in the European war; Andrew Taylor Still, founder of a new American system of health care called osteopathy had recently passed on; the new system was meeting with public acceptance while being resisted by the MD community.

It was not until the post-World War II years in France that MD physicians and therapists began to achieve a certain amount of public interest from treatment utilizing manipulation. Practitioners used the descriptors "Osteopath", "Chiropractor", "Vertebra Therapist"; recognition of such by medical schools was very vague. These practitioners were few, and often confused with "rebouteux" (bone-setters). In general, such practice was empirical, without medical education and transmitted from father to son. As usual in such situations, some individuals became very well known, having patients who traveled great distances for joint adjustment. In Paris, the names of some MD physicians come to mind who utilized manipulative techniques: Voisin, Leprince, Castaignet, Cintrat, Duron, De Sambucy.

It was also at this time that physi-

cal therapists became interested in manipulation, and grew more numerous in this practice principally under the influence of two individuals: Dr. De Sambucy, Dean of a physical therapy school and Paul Geny, also Dean of a school located on Boulevard Saint Michel. In 1955, Geny founded the French School of Osteopathy (EFO), which grew rapidly and produced a number of successful students. Emile Wanono was an English-trained DO who established a study group in Paris. As a practitioner, he was well known by sportsmen of that era. Many in this group of individuals came together to form the **Society for Osteopathic Research (SRO)**. Meetings were numerous. The consideration that osteopathy should be regarded as a specialization of physical therapy led to the use of the title MKDO (Physical Therapist DO).

In 1960, Paul Geny, seeking more accreditation for his teaching, established greater contact with English DOs who came to Paris to lecture: Thomas Dummer, Denis Brookes, John Wernham, ...Bradbury and others. During this time also, legal action on the part of the French MD Association led Geny to transfer the **French School of Osteopathy** from Paris to London. Although this enabled Geny to work more closely with Dummer, the two men eventually separated. Thomas Dummer remained as Dean of the college in London, which eventually became known as the **Maidstone College**.

In 1962, I was one of a group of practitioners seeking more knowledge of osteopathy. This group began to meet with Denis Brookes, and through him were introduced to the Cranial Concept of William G. Sutherland, DO. The beginning of our study was arduous for at least two reasons: The newness of the subject, and the difficulty in language communication ("frenchglish"). It was through Denis Brookes' relationship with American practitioners that the Sutherland Cranial Teaching Foundation (SCTF) came to Paris in 1964. The faculty who gave birth to the Cranial Concept in France consisted of Harold I. Magoun, Sr, DO, FAAO, Viola M. Frymann, DO, FAAO and Thomas F. Schooley, DO. Having been students of Sutherland himself, these osteopathic physicians provided an educational experience of the highest caliber. Doctor Magoun had earlier prepared and published the text *Osteopathy in the Cranial Field* (*) as a tribute to the original work of Doctor Sutherland. Following this inaugural course, these teachers returned to Paris on other occasions to help improve our understanding of the Cranial Concept.

Some years later, I, along with others of our group (Queguiner, Peyralade and Lamontellerie), decided to establish an association having the goal of transmitting this teaching. It was thus that the complete teaching of osteopathy, including the Cranial Concept, was begun in France. Denis Brookes continued to

contribute much to the teaching of osteopathy in France. His contact with various groups contributed to the birth of various colleges, which stimulated greater interest in osteopathy. Increasing public acceptance contributed to the growth in numbers of practitioners. Physical therapists often practiced either by mixing physical therapy with osteopathy or by emphasizing osteopathy. The French Medical Association actively sought to limit the increase of illegal practitioners through court judgments. Some practitioners received heavy fines, while some received symbolic fines. Public acceptance often mediated between the two. Despite this, there were instances of MD understanding of the interest in osteopathy which led to integration of manipulative approaches in their practices. The initiative of the Dean of the Faculty of Medicine of Bobigny (Paris), Doctor Cornillot, established a teaching program for MD practitioners given by non-MD osteopaths.

Over the years, the osteopathic struggle for official recognition has required that the French osteopaths renew their effort with each change of Ministry. It may come as a surprise to many to learn that in October 1956, Frederick Dupont, a delegate of the Seine area, tabled discussion in the French National Assembly of Motion Number 8851, which had as its object the establishment of a National Diploma of Osteopathy.

What is the future of osteopathy

in France? The best guarantee for the future is the demonstration of osteopathy's value and efficacy through the rigorous practice of the science of Still and Sutherland. There is now less problem with the recognition of osteopathic practice by MD physicians. (+) The risk lies in dissociation from the original philosophy by reduction to manipulative techniques. The ideal would be to create a university diploma having a common basis with the MD curriculum. The practice would be essentially manual, with the goal of facilitating structural integrity of the body in accordance with the concept of Still. This is not in opposition to orthodox medicine, but rather an opening of the art of health care for the benefit of greater numbers of patients. □

(*) **Editor's Note:** At the time of the inaugural SCTF Course (1964), the text utilized was the original 1951 version. The frontpiece specifies: "Compiled by The Osteopathic Cranial Association; Harold I. Magoun, AB, DO, MSc (Hon.), Editor. Approved by William Garner Sutherland, DO, DSc (Hon.), Author of *The Cranial Bowl*."

(+) **Translator's Note:** Since this document was prepared (1990), the French government has enacted recognition for osteopathic practice by MD physicians and limited license practitioners.

Watch your Mail!

2004 CME Course Manual goes to press

**Integrating
Manual Medicine
into Patient Care
through
Hands-on Workshops**

**The Art of Caring
The Power of Touch
The Science
of Osteopathy**

American Academy of Osteopathy®
3500 DePauw Blvd., Suite 1080
Indianapolis, IN 46268
Phone: 317/879-1881
Fax: 317/879-0563

Website:
www.academyofosteopathy.org

The Osteopathic Education

Alistair C. Moresi, Bachelor of Applied Science (Osteopathy)

As an Australian trained osteopath, it has been an extremely challenging and rewarding experience to work and teach in the United States (U.S.) for five of the last seven years.

For two years (1999-2001), I was a member of clinical faculty at Touro University College of Osteopathic Medicine (TUCOM) in Vallejo, California. I helped teach osteopathic manual medicine (OMM) eight hours a week to freshman and sophomore classes (first and second years).

It was during this time that I became interested in the differing osteopathic educations that were offered and began to investigate the different courses. Having been a student examiner in both countries, it is very interesting to see where the focus of each system lies.

Neither country has a comprehensive understanding of the others educational systems, for why should they? It is not of prime importance to either as there is no licensing reciprocity, thereby making work in the other country virtually impossible.

Comparisons are often odious; the apples and oranges aphorism springs to mind. This article attempts not to draw conclusions but to purely educate. Both countries educational systems have been influenced greatly by the various political pressures each face from within their own community and the healthcare community at large. Neither is the perfect osteopathic education. Incorporating osteopathic philosophy into a standardized educational system has proved daunting and frustrating from the onset of our pro-

fession, no matter what country!

An analysis of the education offered will hopefully elucidate how we differ. Australian osteopaths generally think of U.S.'s Doctors of Osteopathy (DOs) as being allopathically strong and osteopathically weak. U.S. DOs, on the other hand, often cannot accept the fact that Australian osteopaths have restricted licenses (meaning they have no surgical or pharmaceutical rights). That is generally the first question U.S. osteopathic students ask, "You are not a doctor are you? Are you the same as a chiropractor then? What do you do"?

Most U.S. DOs do not realize that Australian DOs are trained as primary healthcare practitioners, able to see patients in a primary healthcare setting, make a diagnosis and refer to the appropriate allopathic specialist. To be classed as primary healthcare and fit into the private healthcare system a comprehensive allopathic education is required. All fields are studied including subjects like pharmacology and OB/GYN. For U.S. DOs it is probably helpful to think of Australian osteopaths as somewhat equivalent to an especially well-trained physicians assistant/nurse practitioner or naturopath who has spent five years specializing in OMM.

My interest was piqued when I observed histology and pathology texts that were common in both countries. I had always assumed that the Australian education would lag in the non-osteopathic subjects.

This is one of the assumptions that careful analysis of courses may force

us to reconsider.

The two institutions I compare were chosen due to my familiarity and access to them. These are, 1) my alma mater, Royal Melbourne Institute of Technology (RMIT), and 2) my recent employer, Touro University College of Osteopathic Medicine (TUCOM). It is reasonable to assume given the standardized education required in both countries that the general premises can be extrapolated to include the other osteopathic universities and colleges.

There are three Australian osteopathic schools. The RMIT education is a five-year full-time Bachelor of Applied Science (Clinical Science), Bachelor of Osteopathic Science degree. The double degree entails five years of classes with students getting their practical experience by treating patients in student clinics under supervision.

There are 19 U.S. osteopathic medical schools. The TUCOM education is a 4-year full-time DO degree. This includes 2 years of classes and 2 years of month-long rotations in various medical/osteopathic settings (e.g. family practice offices, surgery, ENT, ER) This is followed by a mandatory minimum one-year of hospital internship.

In the Australian tertiary educational system you can enter from high school into your specialized tertiary course. In the U.S., you must first complete a general degree. To compare the level of secondary (High School) education would be another paper and best left to someone with expertise in

that field. It will suffice to say that there are obviously differences.

Medical schools in the U.S. typically require that applicants have a BA or BS degree in any discipline from a four-year accredited college. The schools also require a minimum level of preparation in sciences: one year each of biology, chemistry, organic chemistry and physics. To meet this requirement some students take some of these courses in addition to their degree requirements, either during the degree program or after finishing the degree program.

The two countries use different unit systems to allocate for different subjects so for simplicity of comparison the numbers have been converted to actual required contact hours (i.e.: lectures and compulsory labs/tutorials) for that particular subject. See Table 1.

The numbers are accurate to the best of available calculations and information but in some instances it is

possible there may be an error of several hours. Some related subjects are also grouped together for ease of comparison.

These figures illuminate certain patterns. U.S. osteopathic education focuses much more on allopathic diagnosis and treatment with a small amount of osteopathy. U.S. DOs do three times the amount of allopathic diagnosis and treatment than Australian osteopaths. The Australian system's focus is on osteopathy with a smaller focus on allopathic diagnosis and treatment. Australian osteopaths do ten times the amount of OMM than U.S. DOs.

Both educations reflect the differing roles DOs play in their healthcare system and the public expectations of each country. In the U.S., the vast majority of osteopaths function as medical physicians and are trained accordingly. The most significant part of their training is spent in hospital and outpatient settings. To a greater ex-

tent than other periods during their osteopathic medical education the quality of instruction during rotations can range from outstanding to abysmal.

In Australia, the vast majority of people consult with osteopaths purely for their osteopathic manipulative skills. Primary healthcare skills are vital as are competency in osteopathic manipulative medicine. Expertise in hospital settings is redundant, as osteopaths do not function in that capacity.

Both educational systems are geared towards and result from how DOs function in that society. The merits of the different systems are presented for individuals to muse over. In my experience both countries have had outstanding individual teachers dedicated to providing students with the best possible education. Although there are significant differences between the two countries' osteopathic education there is also a large common ground, which is often overlooked in comparisons within our profession.

More unites us than divides us. □

This article would not have been possible without the help of Sandra Merchant of TUCOM and Ray Myers and Matthew Moresi of RMIT.

[Editor's Note: The hours furnished in this article were from the registrar's office, as such they were accurate for the time. There is more Bio Chemistry than shown because it is part of the Basic Science Foundation Courses (Biology/Physiology).]

Table 1. Contact hour comparison

	R.M.I.T. (hours)	TOURO (hours)
OMM	1573	155
ANATOMY	377	155
BIOCHEMISTRY	76	16 + (128 pre-med.)
BIOLOGY/PHYSIOLOGY	276	257+(128 pre-med.)
MICROBIOLOGY	91	70
PATHOLOGY	143	109
RADIOLOGY	221	310 (2 rotations)
ALLOPATHIC DIAGNOSIS & TREATMENT	1371	4451*
TOTAL	4128 hours	5487 hours

*The US students achieve such large number of hours in this subject heading because essentially for the two years of rotations they average approximately 40 hours a week.

“The Energy cyst”: Its Ramifications and Use in Osteopathic Manipulative Management

Richard C. MacDonald, DO

During the seven-year period that John Upledger, DO, FAAO participated on the faculty of the Osteopathic College at Michigan State, he developed some important concepts which have been very helpful to this author in the osteopathic manipulative management of our patients. One of Dr. Upledger's concepts was given the name “Energy Cyst” by Elmer Green PhD during a workshop at Menninger Clinic. Dr. Upledger has explained the “Energy Cyst” concept in his books.* In this article, I will try to give my perception of this concept and how it has been used in the care of our patients.

The Energy Cyst is an area of the body which has been energetically encapsulated and it has totally unorganized energy within the cyst. The term *entropy* is used to describe this encapsulated energy. The flow of body energy must move around it. The Energy Cyst can disturb energy centers and acupuncture meridians. It sends out independent concentric interference waves which are *not* in synchrony with any other rhythm of the body. The interference waves begin at the cyst in small concentric circles and move out from the cyst in larger concentric circles. The reaction is the same as a pebble falling into a

quiet pond with the flow of concentric energy waves or ripples, small to large, from the impact point of the pebble. The interference waves do not stop at the skin but can be felt in larger concentric waves outside the body.

The Energy Cyst develops from a force that usually comes into the body from the outside. An example would be a fall on the extended arm. A *straight line* of energy goes into the hand – arm, shoulder, neck, chest or head.

The force causes the body to make one of three choices. If the force is not severe it can go through the body and thus be dissipated. Second, the force stays in a straight line of entry and somewhere along the force vectors the body is able to dissipate it before any energy cysts can develop. Thirdly, the area of the body involved is not able to dissipate the influences of the forces and it develops an energy cyst with all its entropic qualities. I have encountered *several* cysts along the straight line of entry of a given force. This occurs because the position of the arm changes over the multiple milliseconds of the fall creating numerous potential sites for energy cysts to develop.

If a force comes into the body and cannot be dissipated the body will

isolate and protect the area by developing the energy cyst. When possible, it is important to find and help release the energy cyst because, over time, it can cause neuromusculoskeletal dysfunction and even articular arthritic problems. In the visceral arena the energy cyst can become the site of a disease state and perhaps be the precursor for severe illness. It is an expression of tissue memory at its best.

I believe energy cysts can form from physical, emotional, mental or spiritual experiences. Emotional energy cysts can develop in children simply from shouting at them and pointing at them with great emotion. Where the finger points is where we find the energy cyst. Many times it is in the heart or the protecting pericardium or both.

The emotional state of the person who is exposed to the forces of the energy cysts is a *key factor* in its development. Negative emotions of guilt, fear, anger, terror seem to predispose us to the energy cyst development. This probably occurs because of the lack of general body homeostasis in these individuals and makes them more susceptible on an energetic and physical level.

There are several methods that can be used to find energy cysts, but the *least* effective of these is verbal information from the patient.

*Upledger, J.E. 1987. *Craniosacral Therapy II, Beyond The Dura*: Eastland Press.

*Upledger, J.E. 1990. *Somato-Emotional Release And Beyond*: Upledger Institute Publishing.

Method I

At the 2001 AAO Convocation, Hollis H. King, DO, PhD, FAAO lectured to the academy membership on the Upledger concept of “vectoring”. When we visualize the person as a “stick person” and we visualize a broken or disrupted site, that area can contain an energy cyst. Releasing that cyst will usually help realign the person’s

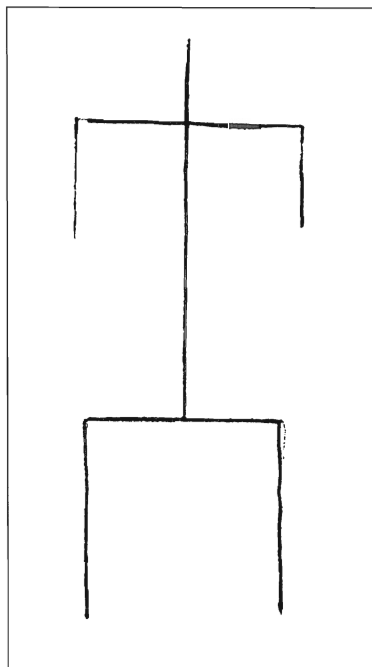

Normal Vectors

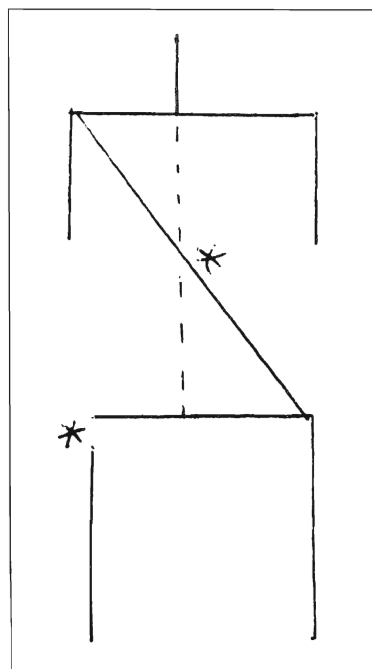

Asymmetrical Vectors

asymmetrical vectors. The method of vectoring can be used as a diagnostic visualization at the beginning of the patient evaluation. Vectoring can also be used at the end of the treatment to assess change as a post treatment evaluation. The diagnosed distorted vectors usually will be more aligned than they were at the beginning assessment. At the end of the treatment the vectors can also be aligned more thoroughly by manually connecting the distorted vectors.

Method II

Palpate the cranial rhythm at several sites on the body. The rhythm will be distorted at the site of an energy cyst. From your numerous palpations the cyst will be found at the greatest area of depression of internal or external rotation of the cranial rhythm.

Method III

When testing the body fascia longitudinally by gently tugging from the cephalad and caudal directions supine and prone – we may find an energy cyst at the site of the greatest restriction of motion. The knee is a common location of the reaction to the fascial drag or glide dysfunctions.

Method IV

“Arcing”, another Upledger concept, is a method for finding an energy cyst. I think this method is the best method to directly locate the energy cyst because it is also an energy technique, as is vectoring. When we “arc” the body we are focusing in on the energy cyst by placing our two hands on various arcs of the concentric circles of energy emanating from the energy cyst. This method is an energy technique and can expand our intuitive abilities greatly.

As an example, let us say the energy cyst lies within the gall bladder. The gall bladder is, therefore, emanating concentric interference waves.

Place your hands gently on the *bilateral* ASIS of the pelvis. Each hand will feel a 20 to 40 per minute subtle back and forth vibration under each hand. Since the left hand, at the right ASIS, is closer to the gall bladder that left hand will feel a narrower arc than the right hand. In addition, each hand will be detecting the arcs of different interference waves. If we do several of these hand positions around the body we will detect arcs which, if we draw a straight line *radius* from each arc, will take us to a *center point* where the radii will cross each other. This is the center of the energy cyst. This technique is particularly valuable in diagnosing dysfunctions in newborns and infants as well as confused, elderly or unconscious patients. Be aware that multiple cysts can be found in one person.

On a visceral or somatic level the energy cyst is part of the “facilitated segment”. It is the target for potential visceral or somatic dysfunction. From the perspective of my approach to the treatment of the area it doesn’t matter whether the dysfunction is visceros/somatic or somato/visceral etc. The important thing is to find the somatic dysfunction and the visceral dysfunction and treat the energy cyst with a three-part approach.

One – Unwind the energy cyst at its diagnostic site. Such as the gall bladder. (Technique two to follow)

Two – Mobilize the somatic dysfunction portion of the facilitated energy cyst-segment T9. (gall bladder)

Three – Mobilize the dural tube from the occiput and from the sacrum by gentle traction. Evaluation of the dural tube sometimes gives the perception of being stuck at the somatic dysfunction vertebral level.

One important suggestion is to treat *all* of these *three* parts at the *same visit* in order to insure change in the patient’s state.

There are two approaches which can be used to release the energy cyst.



1 – Energy Cyst – Gall Bladder

2 – Right Hand on L
ASIS (arc) with radius

3 – Left hand on R
ASIS (arc) with radius

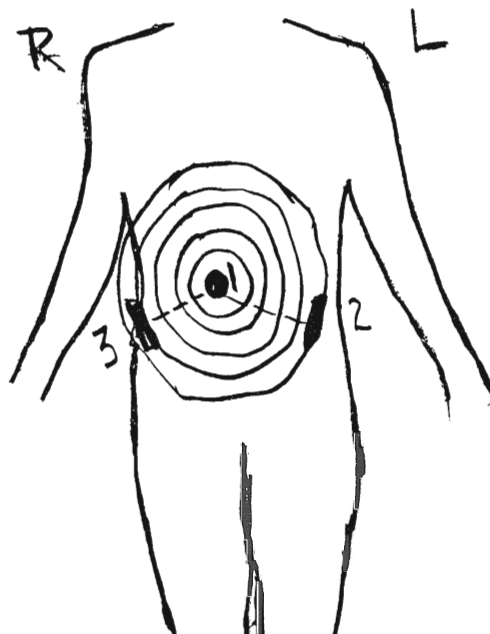

Technique I – Example: An energy cyst has been localized in the right arm. Have the patient seated on the treatment table. You stand behind patient. Grasp the patient’s right shoulder with your left hand and your patient’s lower right arm with your right hand.

Take up gravity by raising the patient’s right arm with your right hand. Allow the patient’s right arm or, if necessary, by their motion activity, the whole body to unwind. The patient’s tissue memory related to the energy cysts will govern their unwinding process. The physician’s left hand on the patient’s right shoulder will monitor the cranial rhythm response. By perceiving and monitoring the cranial rhythm we will find the important places to wait because the cranial rhythm will stop at a deep level and abruptly at those places. This can happen multiple times. At the stopped points energy will then come out of the cyst in the direction opposite to its straight line entry. The operator does not need to do anything but take up gravity and follow the patient’s local or whole body unwinding process. When the patient has finished unwinding for the session, a regular cranial rhythm will return.

Technique II – Example: Have the

patient lie on the treatment table supine. Place one hand anterior and one posterior to the energy cyst (i.e.- the gall bladder). Allow the cyst between your hands to unwind and release its tissue memory.

The same cranial rhythm response will occur in certain positions of unwinding of the tissue as technique I. Always allow time for multiple releases. The multiple hands approach, with the help of one or more assistants, can help speed the releases especially if you are treating multiple energy cysts during one visit.

You should stay with the process of releasing the energy cyst to its *conclusion*. The conclusion is the return, for several moments, of the cranial rhythm smooth and regular – perhaps with more vitality. The entire energy release from the energy cyst may not occur at just one appointment, but it will lose some of its “charge” at each visit. Future visits can be used to complete the release.

The release of the energy cyst occurs during the stopped cranial rhythm. The quiet time does not occur over a period of time as in the CV4. The stopping of the rhythm is abrupt, deep and very still. This period of stopped rhythm is called a “significance detector” by Dr. Upledger.

One consideration to keep in mind, in the release of the energy cyst, is the potential for “Somato Emotional Release” – a copyright Upledger term. The development of the energy cyst may have emotional components. These emotional components may come up and out when the cranial rhythm has stopped and energy is being released. The emotional portion may or may not relate to the circumstances surrounding the development of the cyst.

Energy cysts may exist in the body of a patient for many years without their awareness. It may appear with a new trauma of some kind (not just physical) or may begin to demonstrate itself as the person ages and the energy to keep it unconsciously suppressed, wanes.

The energy cyst concept, and its models of diagnosis and treatment, is a very osteopathic hands on technique and can be added to any manual osteopathic approach. It has enhanced my awareness, on a subtle level, and has become part of my approach to patient care. □

Address correspondence to:
Richard C. MacDonald, DO
860 U.S. Highway One, Suite 211
North Palm Beach FL 33408
Phone: (561) 622-7677
Fax: (561) 622-0798

Physiatrist Needed Monroe, Michigan

Exciting opportunities for an OMT Specialist and a board eligible/certified Physiatrist with an interest in Manual Medicine to join an expanding Osteopathic PM&R Practice. Great team of physicians, therapists and support staff. Family oriented community in Southeastern Michigan. Excellent benefit package, including productivity bonuses.

For consideration, please mail or fax C.V. to: Rehabilitation Specialists of Monroe, PC. Attn: J. McManaway, 876 Steward Road, Suite D, Monroe, MI 48162. Phone: 734/241-0560 or Fax: 734/241-3230.

Dynamic Strain-Vector Release: An Energetic Approach to OMT

Jan T. Hendryx, DO and Richard L. O'Brien, DO

Summary

Dynamic Strain-Vector Release (SVR) is a technique of releasing tissue strains “energetically”. It requires palpating a dynamic primary strain-vector with one hand at an area of somatic dysfunction, finding the endpoint of the strain with the other hand, holding the endpoint through a still point, and allowing for the release of the strain. Tissue is then reassessed for normal inherent motion, texture, and tenderness. Dynamic strain-vectors can be palpated in any direction along the surface of the body, into the body, through the body, or off the body in the human energy field. Dynamic Strain-Vector Release is an excellent technique for releasing acute or chronic somatic dysfunctions that are often not amenable to the usual physically oriented OMT techniques. The purpose of this article is to discuss an energetic OMT technique that we term, Dynamic Strain-Vector Release.

Introduction

Osteopathy is a constantly evolving system of healing. Since the basic tenets of the philosophy and principles of our practice were first laid down in the late 1800s and early 1900s by Andrew Taylor Still, osteopathic physicians have devised numerous manipulative techniques to remove obstructions to health and to restore homeostasis. The primary goals of OMT have been to normalize structural-functional relationships, restore normal arterial vascu-

lar supply, reduce venous/lymphatic/CSF stagnation by facilitating drainage, improve neurological function, remove viscerosomatic and somatovisceral facilitated reflexes, stimulate the immune system, eliminate pain, and prevent recurrences. Additionally, OMT can improve emotional health by releasing stored emotions that often accompany somatic dysfunction.

Our knowledge of the scientific basis of osteopathy, somatic dysfunction and OMT has been partially elucidated by such great researchers as Louisa Burns, DO,⁸ John Denslow, DO,¹⁹ Irvin Korr, PhD,^{29,30} K.A. Buzzell, DO and E.L. Hix, DO,³¹ Viola M. Frymann, DO, FAAO,²¹ and many others. This research has led to models that are primarily biomechanical-neurophysiological-anatomical in nature. Energetic models of healing are most commonly advanced with respect to such therapies as acupuncture,²⁷ Qi Gong,¹¹ Reiki,⁵³ Therapeutic Touch,³² Jin Shin Jyutsu,⁷ Polarity Therapy,^{56,57} and Homeopathy. The basic concept behind these “energy therapies” is that humans are not just physical-biochemical in nature. Human beings have an energetic life force that flows through them and is emitted by them. This energetic flowing life force goes by various names such as L-field,⁹ chi, prana, vital force, subtle energy, spirit, breath of life, tide, potency, etc. and has a crucial role in health. We are not talking necessarily just about con-

duction of electricity in the nervous system and muscles. This is an expanded concept beyond what is taught in conventional physiology. However the osteopathic profession still seems reluctant to embrace, incorporate, or even talk about these “energy medicine” concepts to help to explain OMT and healing. Energy medicine has a solid scientific basis in biophysics and is rapidly becoming part of the therapeutic approach to patients.^{24,25,43}

Interestingly, energy medicine goes back to the roots of our osteopathic profession. A.T. Still studied and practiced energy medicine in the form of “magnetic healing” during the 1870s.^{26,62} Both he and D.D. Palmer (founder of the chiropractic profession) were apparently students of a magnetic healer by the name of Paul Caslin in Ottumwa, Iowa prior to birthing their respective professions.^{3,10} Dr. Still later reflected on the spiritual energetic nature of man in his discourses on “biogen”.⁵⁴ J. Martin Littlejohn, DO spoke of vibration and “vibratility” in connection with the cerebrospinal fluid and vital force.³⁴ William Garner Sutherland, DO taught about “potency” as the (energetic) force behind the primary respiratory mechanism.⁵⁸ More recently, the late Robert Fulford, DO was always open to discussion about “energetic streams” and “vibration” with students and colleagues.^{22,23}

The concept of matter interlinked with energy is a basic law of physics



as elucidated by Einstein. The famous equation $E=MC^2$ states that energy and matter are inter-convertible and matter is simply condensed energy.^{24,43} Dr. Still also wrote about what might be interpreted to be matter-energy conversion.⁵⁵ Carl Phillip McConnell, DO, in an article on “Relatedness” that appeared in the *JAOA* in November 1939 wrote, “Although the essence of applied technic is the mechanics of mass and motion, the facts of physiological relatedness rest in the ‘oneness’ of the organism. In a particular sense matter and energy are discontinuous.”³⁸

The influence of kinetic energy (energy of motion) in the human being can be palpated in living tissues as they move through the flexion and extension phases (expansion and contraction) of the cranial rhythmic impulse. Energy is palpable when tissue enters a “still point” as a high frequency vibration, activity, or therapeutic pulse. Energy is palpable as thermal projections emanating from the human body in areas of visceral or neuromusculoskeletal dysfunctions,¹ from acupuncture points⁵⁰ and chakras.⁶ Energy is palpable as vibratory fields around an individual.^{22,32} Energy is palpable as an emotionally stored “energy cyst” consisting of concentric arcs.⁶³ Energy is palpable as a “listening”, which allows one to find and treat a key area of somatic, visceral, or emotional dysfunction.² Similarly, one can palpate an energetic *dynamic strain-vector* moving from a dysfunctional area along the surface of, into, through, or out of the body. ENERGY IS PALPABLE! And energy can be manipulated!

So if energy is palpable and inextricably linked with matter (i.e. the body), shouldn't one of the primary goals of OMT be to restore *energetic homeostasis* as well as physiologic homeostasis in the patient? If we were able to correct energy dysfunctions, logically it would follow that somatic dysfunctions would also correct.

Given the vast amount of osteopathic clinical and research literature, there is a relative dearth of information discussing the relationships of *energy* and OMT.⁶⁸ The term appears in the name of the OMT technique known as “muscle energy”, but the neurophysiological understanding of its efficacy is based upon Golgi tendon organ and muscle spindle reflexes, reciprocal innervation, and crossed extensor reflexes.²⁰ Upledger has used the phrase “direction of energy technique” when describing V-spread for release of dural membranes, cranial sutures, and somatic dysfunction.⁶⁵ R. MacDonald, DO⁴⁰ and John Upledger, DO^{63,67} formulated the concept of the “energy cyst” describing a walled off area of emotions and trauma within the body, which must be addressed in working with a patient's healing process. Hugh Milne, DO⁴¹ added an expanded energetic-spiritual-emotional dimension to craniosacral therapy. Judith A. O'Connell, DO, FAAO put forth the concept of bioelectric activation of the fascia and discussed its piezoelectric properties with respect to myofascial release.⁴² R. Paul Lee, DO, FAAO discussed energetics related to osteopathy, acupuncture, and spirituality.³³ Zachary J. Comeaux, DO, FAAO recently reviewed the role of vibration and oscillation in osteopathic thought and practice.¹³

Strains

The term “strain” has different meanings to different people and different disciplines. Patients often present with complaints that they “strained” their backs after lifting something. “Strain” has long been a formal diagnosis accepted by physicians, healthcare institutions, and health insurance organizations.

Physics defines a strain as a relative change in dimensions or shape of a body or object that is subjected to stress. Stress is the ratio of a force F to the area A (or F/A). Strains are

classified as either longitudinal, shearing, or volume depending on the direction of the force vectors. In longitudinal strains, the object is lengthened (tensile strain) or compressed (compressive strain) along a longitudinal axis. In shearing strains, part of the object receives a force from one direction, and another part of the object receives an equal force from the opposite direction with the resultant force vectors being tangential or diagonal. Thus depending upon the direction of force (i.e. force vector) we have: 1) tensile strains, which lengthen body tissue resulting from forces pulling in opposite directions along a longitudinal axis; 2) compressive strains, which shorten body tissue resulting from a force pushing along a line; and 3) shearing strains, which distort body tissue resulting from force vectors in two opposite directions on a transverse axis. Volume strains result from a fluid under hydrostatic pressure producing a compressive force on an object immersed in the fluid or equally distributed on the walls of the container.⁵¹

From an orthopedic standpoint, strain is narrowly defined as a muscle injury (as opposed to sprains, which are ligamentous injuries) that results from excessive forcible overstretching or forceful contraction. Muscle strains are classified according to the degree of severity of objective findings. First-degree strains are considered mild with pain, spasm, edema, localized tenderness, and temporary mild partial loss of function; second-degree strains are considered intermediate with more severe symptoms, ecchymosis, and partial tissue disruption; and third-degree strains are considered severe with complete disruption of muscle fibers, accompanying hematoma, and total loss of function.⁵²

In osteopathic terminology the concept of strains includes the classical orthopedic definitions but is expanded beyond muscle to describe other musculoskeletal structures that

have tissue distortion with deformation.⁶⁹ Thus there are described “ligamentous articular” strains, “intraosseous” strains, non-dural and dural “membranous” strains, and various cranial physiological and pathological strain patterns of motion.³⁶

The Dynamic Strain

The term “dynamic strain”, as used in this paper, can be defined as a palpable distortion of motion in the tissue and/or human energy field that pulls “pathologically” along a certain direction with a certain force (vector), while continuing to move with inherent tissue motion.

A single dynamic strain (“simple strain”) or multiple layers of dynamic strains (“complex strain”) can be found in areas of somatic dysfunction, soft tissues and ligaments, myofascial trigger points, counterstrain points, acupuncture points, over larger painful regions of the body, and in bone. The rhythmic to-and-fro motion occurs at the frequency of approximately⁸⁻¹⁴ cycles/minute comparable to the primary respiratory mechanism. Dynamic strain-vectors may be likened somewhat to the palpatory experience of “listening” as described by Jean-Pierre Barral, DO, MROF.²

Light palpation of tissues over a normal region of the body reveals normal inherent tissue motion. In other words, when an examiner chooses to assess primary respiratory motion in all directions or planes, there is an equal amplitude and direction of dynamic vectors in rhythmic motion occurring under the palpating fingers. A normally occurring “neutral zone”⁶⁶ or slight pause is also noted approximately midway through the inherent motion in one direction (See Figure 1).

In a dysfunctional area of the body, a pathological strain-vector has a larger force (stronger tissue pull) and usually longer length (amplitude) than the non-strain motions in the same or normal areas. The neutral

point is absent along the strain-vector (See Figure 2). The dynamic nature of a pathological vector is also affected by palpating along its length as will be described later.

A pathological strain vector can run in any direction: 1) along the surface of the body; 2) into the interior of the body; 3) through the body to the opposite surface; 4) through the body into the energy field on the opposite side; 5) or off the surface of the body into the energy field on the same side without passing along the surface or penetrating the body (Figure 3).

Developing the Concept

The concept of Dynamic Strain-Vector Release began with an interesting case experience about four years ago by one of the authors (JH).

Case Study

S.O. was a 52-year-old female status-post C5-6 cervical discectomy and fusion who presented to the clinic with complaints of chronic progressively worsening neck pain with radiation, weakness, and sensory disturbance down the right upper extremity along the radial and median nerve distributions. A recent cervical MRI showed some scar tissue possibly impinging on nerve roots, but no deterioration of her fusion and no other new herniations. The patient had palpatory findings of significant somatic dysfunction in the cervical and upper thoracic region with dense intraosseous strains in the fusion. She was treated at a frequency of once a week with acupuncture and gentle indirect/myofascial OMT with fairly significant relief of her pain symptomatology that would last for 3-4 days, and then would return. Some variation in acupuncture point combinations in the neck, shoulder, and upper extremity was used with essentially the same outcome.

After obtaining similar therapeutic

results for five sessions, the patient was examined in the supine position. The examiner’s left hand was placed under the cervical fusion area while the right hand was used to palpate acupuncture points along the right upper extremity to see if there was any way of determining which points might be more therapeutic than others. Points were palpated in a proximal to distal fashion along the various acupuncture meridians in the right upper extremity. It was noted that when certain acupuncture points were touched and held, the patient’s tissues would enter a still point with

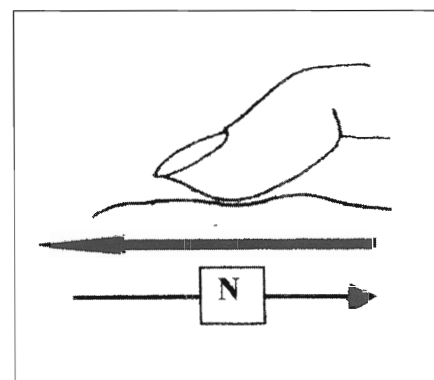

Figure 1. Three-dimensional representation of normal inherent tissue motion. “N” represents the neutral zone, or brief pause, that is palpable at the midpoint of motion.

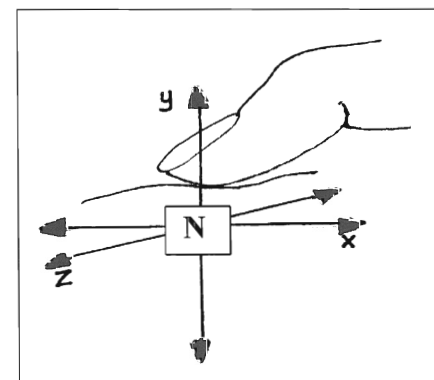

Figure 2. Pathological strain-vector (upper). Notice here that the inherent motion does not pause at a neutral “N” zone. The pathological vector “points” you in the direction of the endpoint. A normal backward motion occurs with a neutral zone (lower).

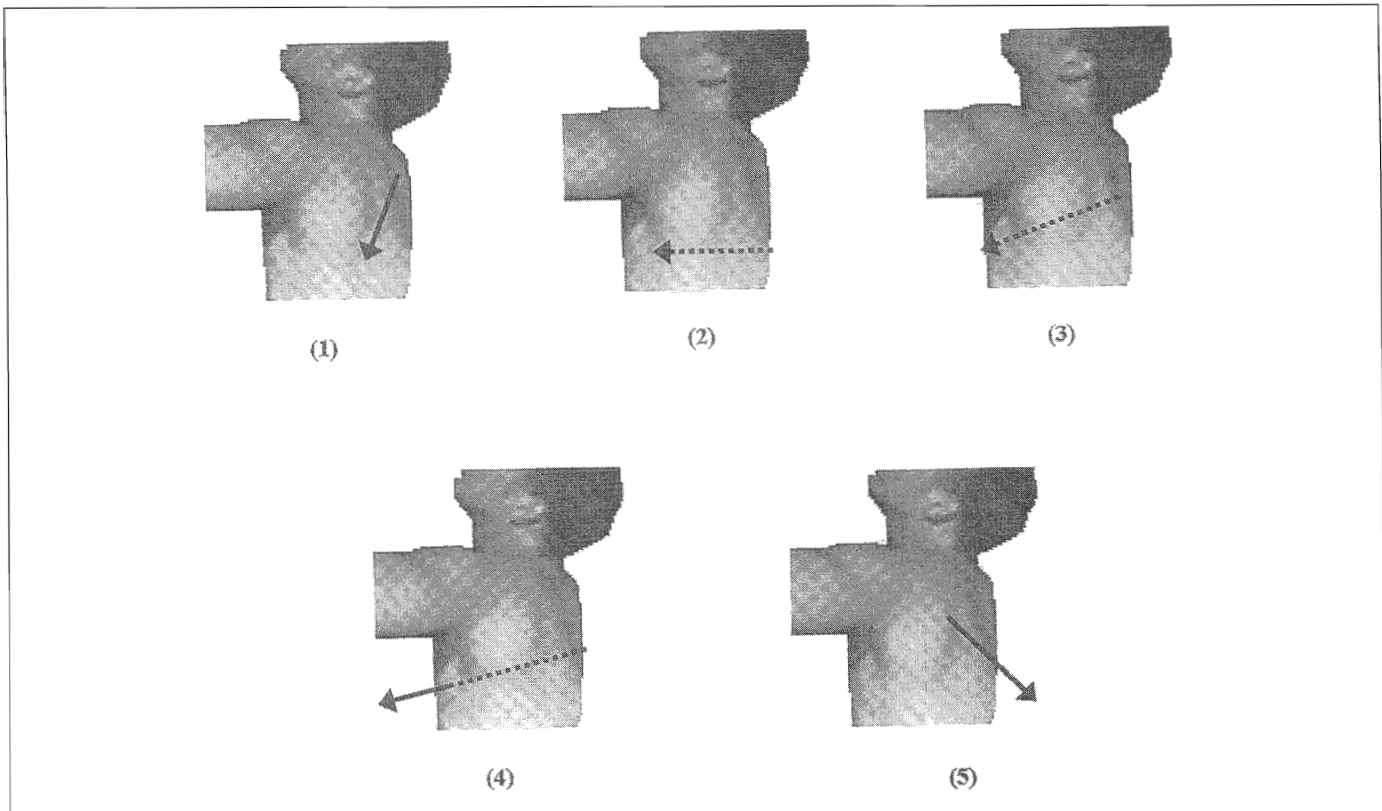

Figure 3. Various possible strain-vectors emanating from an area of somatic dysfunction.

subsequent release of muscular and even intraosseous tension in the neck. Cessation of inherent tissue motion in the neck and under the palpating hand occurred simultaneously. Palpation of certain acupuncture points had no discernible effect on inducing a still point and releasing the tissue, while others had fairly profound effect. It was also noted that prior to the patient's tissue entering a still point, a pulling sensation in the tissues under the left sensing hand increased toward the direction of the acupuncture point that was being palpated. The force of the pulling sensation increased for each point palpated more distally that was effective in releasing the tissues. Finally it was noticed that at the most distal point that was effective in releasing the tissues "endpoint", the tissues under both hands would draw towards each other just before entering a still point. (The intermediate points between the dysfunctional area and most distal point

were eventually termed "secondary or satellite points".) Without doing any acupuncture or any other OMT, the patient reported that her neck and arm pain were minimal. The tissues in her neck and arm had released with improved range of motion. A marked decrease in subjective pain and muscle tension reportedly lasted for almost a week and her pain did not return to the usual level by the next visit.

Over the next few visits, the directional nature of inherent pathological tissue motion of surface strain-vectors was studied and was found to change after each treatment. Different acupuncture points palpated in other regions of her body were also found to release the tissues and decrease the pain in her neck and arm. As "palpatory" treatments continued, the number of points that actively released her cervical and upper extremity tissues also decreased.

We decided to use this palpatory technique of treating somatic dys-

function, counterstrain points, and myofascial trigger points in a number of other patients. We found very early that often the direction of the surface strain-vector at the area of dysfunction did not necessarily follow along acupuncture meridians. Non-acupuncture points on the surface of the body would also release the tissue strain. Eventually it became clear that it was necessary to treat only the endpoint of the strain. Not only would the strain-vector dissolve, but also all intermediate satellite points along the strain would normalize. In other words, satellite points became inactivated after treating the dysfunctional area and exhibited normal inherent tissue motion.

Initially it seemed that pathological strain-vectors were located primarily along the surface of the body. As more patients were examined and our palpatory skills improved, it became apparent that there were also vectors pulling in other directions. Strain-

vectors could be palpated through the body to the opposite surface or into the interior of the body. In the former case, treatment was carried out by touching and holding the endpoint of the strain-vector on the opposite body surface. In the latter, the end point was located by running the treating fingers along the surface of the body in the general direction of the strain and finding the position that would elicit maximal pull or exaggeration on the sensing hand over the dysfunction. By touching this point on the surface and “projecting touch” to the endpoint interiorly, a still point would ensue and the strain and tissue would release. Finally it was realized that the strain-vector could travel completely through the body and out into the energy field at varying distances, or travel directly off the surface of the body without penetrating into the body at all. These were treated by monitoring the point of strain with a finger of one hand, while palpating and holding the endpoint of the strain-vector in the energy field with the other hand. These points were held until a still point was achieved and the tissue released. This last type of strain pattern and release technique is actually very common.

With the sensing hand on the lesion and the treating hand traveling distally along the strain vector toward the endpoint, two things happen: 1) an increasingly large force of pulling sensation (exaggeration) develops and is sensed by the palpating hand along the strain-vector, as if the palpating and treating hand are connected by an increasingly taut rubber band; and 2) the backward direction of inherent motion away from the neutral point diminishes in length. At the endpoint of the strain-vector, the backward inherent motion is completely absent, the pull between the two hands is maximal, and the still point is induced (See Figure 4).

The concepts of simple and com-

plex strains developed from the fact that in some areas of dysfunction, only one strain-vector could be found and once this was released, the pain was gone and the tissue felt normal. Reassessing the area after treatment revealed only normal inherent tissue motion. This was determined to be a “simple lesion”. It was discovered that sometimes after releasing one strain-vector, reassessment of the area would reveal another strain-vector pulling in another direction. After releasing that, another strain-vector might be found and so on. Thus “complex strains” have more than one strain-vector layered. To treat these effectively, they need to be treated in the order that they are found until normal tissue dynamics is restored.

Dynamic strain-vectors are most often linear and originate from rather

small point locations of dysfunction. One can also palpate larger more global vectors that feel planar or even three dimensional in nature. Thus one can place the whole sensing hand over a larger area of the body such as the low back, feel a large dynamic strain pulling in a certain direction, and release it similarly by finding the endpoint and holding through the release of a still point.

Dynamic Strain-Vector Release Technique

1. Lightly palpate an area of somatic dysfunction, muscle spasm, myofascial trigger point, counterstrain point, ligamentous strain, intraosseous strain, or other dysfunction with a sensing hand. Make sure your treating hand is down at your side and is not touch-

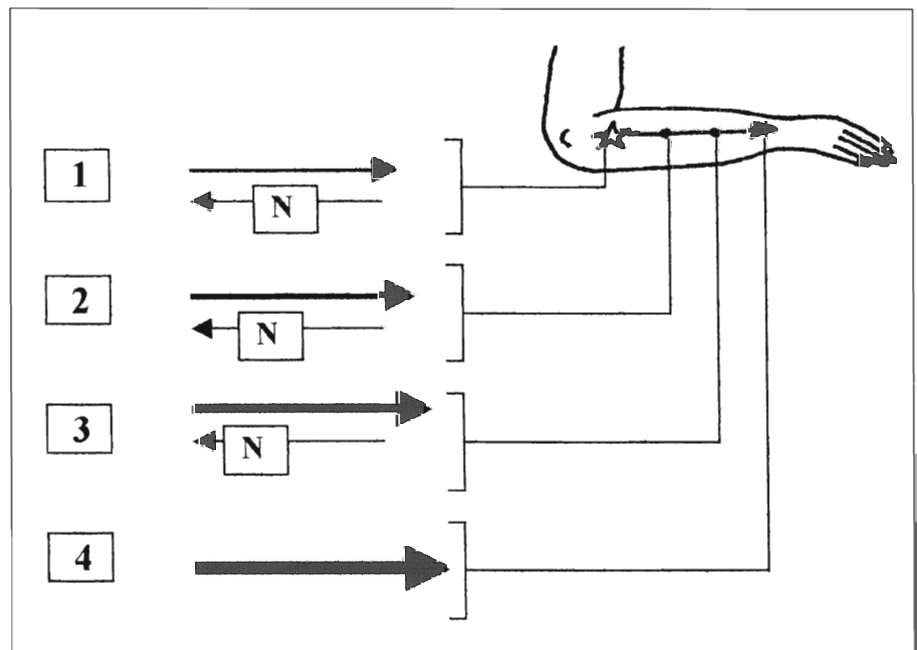

Figure 4. Diagram depicting the palpatory experience with the sensing hand at the dysfunction* while touching various points along the dynamic strain-vector with the other hand. 1) Pathological inherent tissue motion at the dysfunction with the strain-vector pointing to the right. 2, 3) As the points along the strain-vector are touched more distally, notice that the sensation of pulling toward the endpoint increases, i.e. is exaggerated (denoted by progressively thicker arrows). The neutral zone also shifts toward the opposite direction. 4) As the endpoint is palpated, the backward tissue pull toward the neutral zone totally disappears and a strong tissue pull is felt only along the pathological vector. It is here that the still point is induced.

ing the patient. Tune in to the inherent tissue motion under the sensing hand.

2. Allow your sensing hand to assess inherent tissue motion in various directions noting normal motion and abnormal motion. Check in at least three planes of motion until you feel a strong pull in one direction. With practice you will be able to immediately sense the dynamic strain-vector without assessing different directions.

3. Place the treating hand or finger(s) near the sensing hand and move it away in the direction of the strain-vector pull. The tension under your sensing hand will increase (exaggerate) as you move the treating hand toward the endpoint, as if a rubber band were attached between the two.

a. If the strain-vector is along the surface of the body, simply move the treating hand along the surface to the endpoint.

b. If the strain-vector is into the body, start with your treating hand at the opposite side of the body. Move your treating hand along the surface until you feel a maximal pull between the hands, and then “project your touch” internally visualizing the point where the endpoint actually is.

c. If the strain-vector extends to the opposite surface, move the treating hand to the endpoint there.

d. If the strain-vector extends through the body out into the energy field, move the treating hand out to the endpoint in the energy field.

e. If the strain-vector extends off the surface of the body without penetrating, move the treating hand to the endpoint in the energy field.

4. When you reach the endpoint with the treating hand, the “tension” between the two will be maximal, inherent motion will stop, and the tissues will enter a still point. During the still point, you may feel a high frequency fine vibration or a thera-

peutic tapping pulse under both hands or fingers through the duration of the still point.

5. Wait for the release. This usually takes from a few seconds to 30 seconds. You will feel a softening of the tissues under your sensing hand, and a softening of tissues, or a collapsing of the energy field, under your treating hand.

6. Remove your treating hand from the body, or the energy field, and reassess. If you do not detect any more underlying strain-vectors, then you are finished and it is a simple lesion. If you detect another strain-vector, release that, reassess and so on until all vectors are gone. This would be a complex lesion.

Discussion

Sensing the inherent primary respiratory motions of the cranial-sacral axis, peripheral limbs, soft tissues, and organs as well as abnormal tissue strain patterns is not a new concept. Palpation of these and other rhythms have been taught for years in courses in osteopathy in the cranial field, visceral manipulation and myofascial release.

The treatment of somatic dysfunctions has traditionally consisted of hands-on body contact utilizing indirect or direct action techniques. The practitioner’s mental focus and imaging has been mostly with the intent of and attention to restoring normal structural and functional relationships on a physical biomechanical or fluid level. Upledger⁶³ has taken the palpation and therapeutic experience beyond the body in his diagnosis and treatment of energy cysts. He discusses in great detail the use of the technique called “arc-ing” to treat these energetic dysfunctions off the body in the human energy field.

Dynamic Strain-Vector Release challenges the concept that somatic

dysfunction and the factors contributing to it are merely confined to the physical body. It extends palpation diagnosis and treatment beyond the body into the energy field and appears to differ from Upledger’s globe or arc-like energy cyst concepts in that the strain-vectors are primarily linear. This technique does not appear to be the same as Upledger’s vector/axis integration and alignment techniques.⁶⁴

Dynamic Strain-Vector Release is also not the same as Neurofascial Release, a technique developed by Stephen Davidson, DO.¹⁷ In Neurofascial Release, a physician palpates an area of dysfunction with one hand and then locates another point on the surface of the body that will release, or increase if necessary, the tissue tension to normalize it. The treatment is directed primarily at the level of the fascia but may also be used to treat articular and intraosseous lesions.^{18,35}

Still point induction has been used extensively in cranial osteopathy and visceral manipulation to recruit a patient’s inherent healing mechanisms. A still point can be induced by a variety of methods such as CV-4, following the limbs into internal rotation and holding, somatoemotional release visualization and dialogue, etc. In the present case study and in other patients, it was demonstrated that multiple still points could be induced by sequentially palpating certain energetically connected acupuncture and non-acupuncture points with one hand while holding the other hand over the area of somatic dysfunction. The tissues in the area of dysfunction would release and normal inherent tissue motion would return under both hands as the still point resolved. K. S. Pribadi, MD⁵⁰ previously noted the same phenomenon while palpating areas of trauma concomitantly with acupuncture points, but did not report sensing a tissue pull between the two hands nor the pres-

ence of dynamic strain-vectors in the area of dysfunction. Interestingly, he also showed that a still point could be induced without physically touching the skin by placing the therapeutic hand directly above the acupuncture point.

Robert Fulford, DO maintained that osteopathic manipulation was not just a biomechanical manipulation of anatomical structures. He championed the belief that healing comes from the natural life force that permeates us all. His opinion was that health problems originate from impediments in the flow of energy through the body—a philosophy very similar to that espoused by Traditional Chinese Medicine and acupuncture. Osteopathic treatment thus removes those energetic impediments and restores health. His sense of touch was so refined that he could easily palpate energy derangements in the human system and correct them appropriately with his hands or the percussion vibrator.²² He often referred to the work of Harold Saxon Burr, PhD,⁹ whose research at Yale Medical School in the early part of this century measured the existence of electromagnetic or L-fields around all living organisms and showed that these fields were abnormal in various disease processes.

Rollin Becker, DO⁴ wrote extensively in the 1960s about biodynamic energy fields and biokinetic energies and forces within the human body that were associated with normal physiological functioning, pathological processes, and trauma. He defined “biodynamic intrinsic force and its potency...as the physiological energy found in health within the patient”, i.e. perhaps the energy behind normal inherent tissue motion. “Biokinetic intrinsic forces and their potencies [were] defined as the pathological-physiological energies...found in disease and traumatic states within the patient”, i.e. perhaps the energy behind pathological strain-vectors. He

went on to say, “It takes added energy from the environment of the patient, in combination with the biodynamic intrinsic force, to produce the condition manifested as a disease or traumatic problem.” Whether he was referring to the “environment” as the human energy field outside of the physical body is unclear.⁵ Dr. Becker abandoned these energetic terms when he felt they were not being appreciated by colleagues and went back to more classical descriptions of Sutherland’s work.

So what is the nature of the energy or energies behind normal inherent and pathological tissue motion? Primary Respiratory Mechanism? Potency? Healing? Still point? Is the energy generated from within the tissues and fluids or does it originate elsewhere?

Traditional Chinese Medicine concepts talk about “chi” or life force and its yin and yang aspects and interactions. Yin and yang represent a polarity concept where yin is defined as the shady side of the mountain and yang is the sunny side. Thus yin represents dark, cold, inactive, contraction, hypostates, negative, etc. and yang represents light, hot, active, expansion, hyperstates, positive, etc. Extensions of these ideas are metaphorically endless. Within the context of rhythmic tissue motions and the primary respiratory mechanism, yin might represent the extension or contraction phase and yang the flexion or expansion phase.

Peter Crisera, DC¹⁴ proposes that the yin-yang concepts do indeed apply to the energy driving the contraction-expansion phases of the primary respiratory mechanism. He also theorizes that there exists a “coaxial energetic core” consisting of internal and external systems and a holographic meridian flow. Internally, the central nervous system transmits and propagates a coherent wave through the CSF in the direction of cephalad

to caudad (cranial-sacral) and corresponds to the central deep meridian flow of the governor vessel (GV) and conception vessel (CV). GV is the acupuncture meridian that runs midline dorsally from the tip of the coccyx up the spine and over the top of the head to the upper lip. CV is the midline acupuncture meridian that runs ventrally from the perineum to the lower lip. Externally, energy is transmitted in the axial skeleton through fluctuations in the piezoelectric activity of bone (and probably fascia). Again energy is carried in GV and CV in a “superficial central meridian flow. Finally, Crisera¹⁵ notes that all six yang meridians of the body (hollow organs) begin (B) or end (E) on the cranium. He calls this third component the B & E holographic meridian flow.

Crisera¹⁶ postulates that it is the coaxial energetic core, which produces and propagates electromagnetic energy in the body. He feels that this system of energy is recharged using what is known as a *Frohlich’s pump mechanism*, which is essentially a biological system of electrically charged dipole molecules. The craniosacral system allows for a resonance to be set up that moves out into the periphery and is translated into biomechanical and bioenergetic work.

Biomechanical work translates into motion patterns in the neuromusculoskeletal system and viscera, while bioenergetic work is channeled into acupuncture meridian flow, electromagnetic properties of the CSF, and what he terms the “substrate receptor system”. The substrate receptor system is the intercellular communication system that includes receptors, microtubules, and junctional complexes.

William Tiller, PhD, a former physics professor and researcher at Stanford University, has proposed what he terms the “Dynamic Equation of Nature” in which he expands

➔

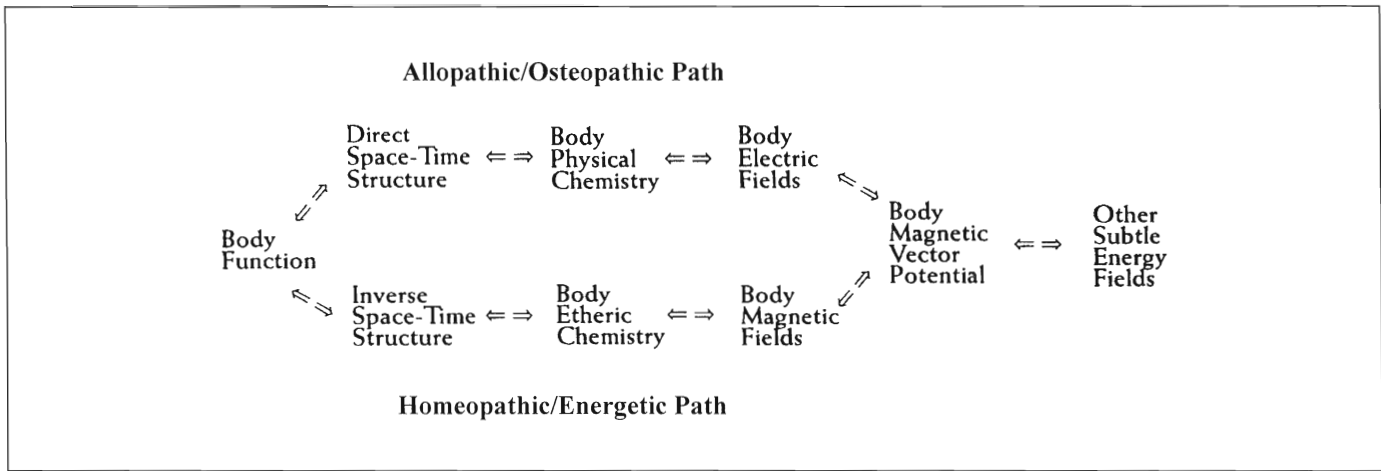

Figure 5. Adapted from Tiller⁵⁹

the structure-function-chemistry model of current allopathic and osteopathic medicine to include both electromagnetic interactions and quantum mechanics. He discusses a number of experiments dealing with subtle energies and healing which eventually lead him to the following concept (Figure 5):

Although a detailed discussion of this diagram is beyond the scope of this article, Tiller makes the point that both paths function in our bodies and that what he terms the “body magnetic vector potential” occupies a key position in bridging the physical and subtle energies. A body magnetic vector potential is theorized to be the bridge between subtle energy fields produced by a healer and pulses of [electromagnetic] energy measured some distance from the healer. He defines subtle energies as “all those beyond those formed from the four well-known [Fundamental] forces that are needed to explain natural phenomena”.

A magnetic force vector, as compared to an electric force vector, may be illustrated by the following figure. As seen in Figure 6, the electric force is a vector directed between two charges. The associated ‘magnetic vector’ of force is directed at a right angle to the electric force vector.

A summary table of the four Fundamental Forces is provided in Figure 7. It illustrates the effects,

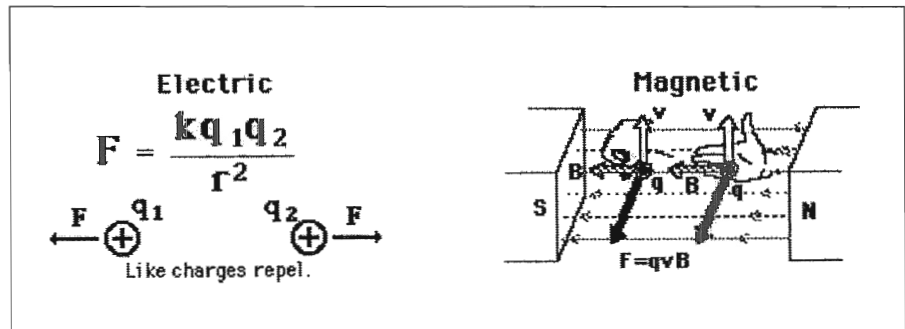

Figure 6. The Magnetic Force Vector - $F=qvB$

(Internet acquired at <http://hyperphysics.phy-astr.gsu.edu/hbase/forces/funfor.html>)

strength, range, and the particles involved for these forces. The STRONG Force holds a nucleus together against the enormous forces of repulsion of the protons. The ELECTROMAGNETIC Force is the force between charges and the magnetic force. The WEAK Force creates the transformation quarks, and thus, makes possible the decay of nuclear particles - necessary for the buildup of heavy nuclei. GRAVITY Force is the force of attraction or (for some theorists) – the force of reduced repulsion – between objects with mass. See Internet Site: (<http://gravity.ontheinter.net>)

Subtle energy phenomena include healing, telepathy, clairvoyance, clairaudience, healing Qi Gong, homeopathy, precognition, auric sight, dowsing, and others. The exact nature of subtle energies has yet to be delineated.⁶⁰

Thus could craniosacral dynamics,

inherent tissue motion, palpatory sensations of dynamic strain-vectors, still points, and human energy fields all have their origins in subtle energies? If this is the case, subtle energies may thus be transformed by body magnetic vector potentials into electromagnetic fields that then act upon the piezoelectric fascia, ligaments, and bones to create the sensation of motion.

Somatic dysfunction often occurs as the result of injury or physical stresses on the body. Palpatory diagnosis of somatic dysfunction is summarized by the acronym T.A.R.T. – **T**issue texture changes, **A**symmetry of motion, **R**estricted range of motion, and **T**enderness. It might be appropriate to add to this definition the presence of **Strain {dynamic/energetic vector(s)}**. In all patients exhibiting somatic dysfunction we have observed associated simple or complex dynamic strain-vectors at the site of the dysfunction. Which came first

Fundamental Forces



	Strength	Range (m)	Particle
Strong 	1	10^{-15} (diameter of a medium sized nucleus)	π , others mass > 0.1 GeV
Electromagnetic 	$\frac{1}{137}$	Infinite	photon mass = 0 spin = 1
Weak 	10^{-5}	10^{-17} (0.1% of the diameter of a proton)	Intermediate vector bosons W^+ , W^- , Z_0 , mass > 80 GeV spin = 1
Gravity 	6×10^{-39}	Infinite	graviton? mass = 0 spin = 2

Figure 7. The Four Fundamental Forces

(Internet acquired at <http://hyperphysics.phy-astr.gsu.edu/hbase/forces/funfor.html>)

– the physical manifestations creating an abnormal energy pattern or the energetic component creating the abnormal physical findings? **The acronym should more correctly be changed to “S.T.A.R.T.”**

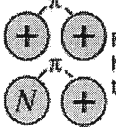
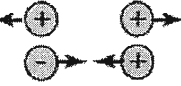
From a traditional osteopathic standpoint, it is assumed that tissue texture changes are due to abnormal neuronal firing resulting in hypertonicity and spasm with possible inflammation and stagnation of fluids often resulting in tenderness. Asymmetrical myofascial tension subsequently results in asymmetrical movement and fixation of a joint in an abnormal position. Of course postural considerations, tensegrity issues, and the psychological state of the patient also play important roles in maintaining dysfunctional patterns.

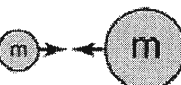
Could the palpatory findings of “S.T.A.R.T.” actually be a manifestation of abnormal energy fields affecting the body?

All human tissues produce and emanate electromagnetic energy fields that are distributed throughout the body and into adjacent extracorporeal areas. Research has shown that the frequencies in these fields range from the extremely low frequency (ELF < 100 Hz) to infrared (10^{11} Hz), microwave (10^{14} Hz), and even light (10^{15} Hz).⁴⁴ Compression or stretching of tissues causes them to emit electromagnetic fields. These fields are a result of both the piezoelectric nature of collagen and streaming potentials.⁴⁵ The fascia, i.e. living matrix, acts as a giant liquid crystal capable of creating large coherent (laser-like) vibrations as a result of oscillations of the large numbers of molecular arrays.⁴⁶ James L. Oschman, PhD⁴⁷ points out that these arrays can receive energy from – or send energy fields to – the external environment much like an antenna. The arrays also allow for rapid intercommunication

throughout the body outside of the nervous system.

These protein molecular arrays are responsible for the ability of tissue to change viscosity from more of a liquid (sol) to more of a dense consistency (gel). Carlisle Holland, DO²⁸ has eloquently discussed the viscoelastic and viscoplastic nature of human tissues and their responses to outside forces. Sol-gel interconversions have been shown to be influenced by electromagnetic energy.⁴⁸ Tissue texture may be viewed as a sol-gel phenomenon. OMT influences gel-sol qualities in tissues.

In somatic dysfunction, tissue texture often feels “harder, denser, ropier, stringier, doughier” than in normal tissue. Perhaps these abnormal tissue texture findings are maintained by local currents of injury and/or electromagnetic fields and are actually energetic phenomena rather than inflammatory ones.

A “current of injury” is well known as the cause behind an abnormal ECG in a patient who has suffered a myocardial infarction. Oschman⁴⁹ points out that a current of injury is actually a low voltage semiconductor direct current that controls tissue repair. All fascia and the perineurium surrounding nerves are semiconductors (i.e. “perineural conducting system”) and actually provide for a different type of electrical conduction than the nerves themselves (i.e. ionic currents). Semiconductor currents can be influenced by magnetic fields. This may explain why tissue abnormalities and pain can be improved by the application of static magnets,¹² pulsed magnetic fields,^{37,61} and even the magnetic energy fields projected from the hands of healers.⁷⁰

The fact that dynamic strain-vectors can be palpated into the human energy field suggests that there is an electromagnetic field component. As the clinician “locks on” to the endpoint of the strain-vector, a palpable

high-frequency vibration can be felt in both the sensing and treating hands as the patient's tissues cycle through a still point. This vibration disappears as the tissue resumes normal tissue motion. Additionally, if the endpoint is in the human energy field, the field collapses at the termination of the still point.

In summary, Dynamic Strain-Vector Release (SVR) is an effective therapy in the treatment of somatic dysfunction. This technique may be used as a primary treatment or for "touch up" for residual pain and dysfunction after other OMT modalities have been employed. It is extremely effective in releasing both acute chronic somatic dysfunctions that are refractory to the other techniques by addressing the energetic contributions to dysfunction that are usually overlooked. It operates from a different model than most traditional osteopathic techniques. Additionally, this technique can be easily taught to students and clinicians.

McConnell, one of the most prolific researchers, writers and visionaries of our profession, pointed out as early as 1938 that "Until we as a profession truly appreciate and understand the role of biophysics, of the necessity of physiological mechanical integration, wherein space, face, and interface, separation and compartment, in their particular associations are in reality the basis of energetics, and consequently of every nervous impulse and of all circulatory requirement, our therapy is going to lack the vital punch of comprehensiveness."³⁹

These words echo loudly in the halls of contemporary osteopathic education, research, and practice. Perhaps not working actively with energy is part of what we are missing as osteopathic clinicians in our limited awareness of looking at the patient through our somewhat fogged biomechanical-neurophysiological-anatomical osteopathic spectacles.

Perhaps this is why we often get limited results with our hands-on attempts at correcting somatic dysfunction even though we have used every OMT technique in the book. Perhaps "the book" is incomplete and we have limited ourselves to limited options. Maybe energy carries the primary dysfunction and thus is the core disturbance in many health problems.

We suggest that in addition to the on-going research into the nature of osteopathic treatment and its efficacy using contemporary physiological and anatomical models, we "S.T.A.R.T." looking very seriously at other models such as biophysics and energetics to elucidate what we are really doing in the attempt to help our patients heal. One study might be to utilize the sensitive SQUID magnetometer to study the magnetic fields of somatic dysfunction, trigger points, and acupuncture points and the magnetic field interactions between healer and patient during a healing session. "Dig on..."

References

1. Barral, J-P. *Manual Thermal Diagnosis*. Seattle: Eastland Press. 1996.
2. Barral, J-P. *Trauma: An Osteopathic Approach*. Seattle: Eastland Press 1999. pp. 183-84, 194-95.
3. Beck, BL. *Magnetic healing, Spiritualism, and chiropractic: Palmer's union of methodologies, 1886-1895*. *Chiropractic History*. The Archives and Journal for the History of Chiropractic. 1991. 11(2):11-15.
4. Becker, RE. In: RE Brooks (ed.). *Life in Motion*. Portland, OR. Rudra Press. 1997. P 182.
5. Ibid. pp. 153-216.
6. Brennan, BA. *Hands of Light*. NY: Bantam Books. 1987.
7. Burmeister, A. with T. Monte. *The Touch of Healing: Energizing Body, Mind, and Spirit with the Art of Jin Shin Jyutsu*. NY: Bantam Books. 1997.
8. Burns, L. *Louisa Burns, DO Memorial, 1994 Yearbook*. Indianapolis. AAO. 1994. pp. 149-260.
9. Burr, HS. *Blueprint for Immortality: The Electric Patterns of Life*. Great Britain: Neville Spearman Publishers. 1972.
10. Clyde, H. *Medical History of Wapello County*. Photocopy of writings on Paul Caster's treatment and mentoring of A.T. Still in magnetic healing. c. 1898. Osteopathic Archives, Kirksville College of Osteopathic Medicine. Kirksville, MO.
11. Cohen, KS. *The Way of Qigong*. NY: Ballantine Books. 1997.
12. Colbert, A. *Acupuncture and Magnet Therapy: Research Update and Clinical Applications*. Lecture and workshop presented at the American Academy of Medical Acupuncture 2002 Symposium, Los Angeles, CA.
13. Comeaux, Z. *The role of vibration or oscillation in the development of osteopathic thought*. *JAAO*. 2000 .10(3):19-24.
14. Crisera, P. *Cranio-sacral Energetics, Vol 1*. Rome, Italy. S.M.I.S.R.L. 1997. pp. 13-14; 48-56.
15. Ibid. p. 56.
16. Ibid. p. 13.
17. Davidson, S. *Neurofascial Release*. Phoenix. Practical Publications. 1990.
18. Davidson, S. *Neurofascial Release Course*. May 2001.
19. Denslow, JS. *Selected Papers of John Stedman Denslow, DO*. MC Beal, DO (ed.). Indianapolis. American Academy of Osteopathy. 1993.
20. DiGiovanna, EL and S. Schiowitz. *An Osteopathic Approach to Diagnosis and Treatment*. NY. J.B. Lippincott Co. 1991. p. 28-29.
21. Frymann, VM. *The Collected Papers of Viola M. Frymann, DO: Legacy of Osteopathy to Children*. Indianapolis. American Academy of Osteopathy. 1998.
22. Fulford, RC with Gene Stone. *Dr. Fulford's Touch of Life*. NY: Pocket Books. 1996.
23. Fulford, RC. *Percussion Vibrator Course*. Huntington, WV. 1989.
24. Gerber, R. *Vibrational Medicine*. Santa Fe. Bear & Co. 1988.
25. Gerber, R. *Vibrational Medicine for the 21st Century*. NY. Harper Collins Publishers, Inc. 2000.
26. Gevitz, N. *The DO: A Social History of Osteopathic Medicine*. PhD Thesis. University of Chicago. 1980. pp. 28-29.
27. Helms, JM. *Acupuncture Energetics: A Clinical Approach for Physicians*. Berkeley, CA. Medical Acupuncture Publishers. 1995.
28. Holland, C. *Viscoelastic Viscoplastic Axes of Motion in the Cranium: The Biophysics of Cranial Osteopathy*. Educational videotape. 1992.
29. Korr, IM. *The Collected Papers of Irvin M. Korr*. Vol. 1. B. Peterson (ed.). Colorado Springs, CO: American Academy of Osteopathy. 1979.
30. Korr, IM. *The Collected Papers of Irvin M. Korr*. Vol 2. H. King, DO (ed.). Indianapolis. American Academy of Osteopathy. 1997.
31. Korr, IM, Buzzell, KA, and EL Hix. *The*

Physiological Basis of Osteopathic Medicine. NY: Insight Publishing Co. 1970.

32. Krieger, D. The Therapeutic Touch. Englewood Cliffs, NJ: Prentice-Hall, Inc. 1979.

33. Lee, JP. Spirituality in osteopathic medicine. JAAO. 2000. 10(4):31-36.

34. Littlejohn, JM. The physiologic basis of therapeutic law. The Journal of the Science of Osteopathy. 1902. 3(4).

35. Malina, B. Neurofascial Release: An Instruction Manual. Chandler, AZ. Self published. 1996.

36. Magoun, HI. Osteopathy in the Cranial Field. Kirksville, MO. The Journal Printing Co. 1966. p. 347.

37. Markov, MS and A.P. Colbert. Magnetic and electromagnetic field therapy. J. of Back and Musculoskeletal Rehabilitation. 2001. 15:17-29.

38. McConnell, CP. Fundamental fragments. II-Relatedness. JAOA. 1939. In Jordan, T. and R. Schuster (eds.). Selected Writings of Carl Phillip McConnell, DO. Columbus: Squirrel's Tail Press. 1994. pp. 129-130.

39. McConnell, CP. The osteopathic approach. JAOA. 1938. Ibid. p. 31.

40. McDonald, R. Personal communication and discussion about the origin of energy cysts at the American Academy of Osteopathy Convocation 2002. Norfolk, VA.

41. Milne, H. The Heart of Listening: A Visionary Approach to Craniosacral Work. Berkeley: North Atlantic Books. 1995.

42. O'Connell, JA. Bioelectric Fascial Activation and Release. Indianapolis. American Academy of Osteopathy. 1998.

43. Oschman, JL. Energy Medicine, The Scientific Basis. NY. Churchill Livingstone. 2000.

44. Ibid. p. 88.

45. Ibid. p. 52.

46. Ibid. pp. 62, 130.

47. Ibid. p. 131.

48. Ibid. p. 170.

49. Ibid. p. 95.

50. Pribadi, KS. Psychosynergisis, a synthesis of cranial osteopathy, acupuncture, and homeopathic medicine in psychiatry. JAAO. 1998 8(1): 29-35.

51. Sears, FW and MW Zemansky. University Physics. Reading, MA. Addison-Wesley Publishing Co., Inc. 1970. pp. 151-155.

52. Simon, RR and SJ Koenigskecht. Emergency Orthopedics. Norwalk. Appleton & Lange. 1987. p. 22.

53. Stein, D. Essential Reiki. Freedom, CA. The Crossing Press, Inc. 1995.

54. Still, AT. The Philosophy and Mechanical Principles of Osteopathy. Kirksville, MO. Osteopathic Enterprise. 1892. p.251-268.

55. Ibid. p. 254-55

56. Stone, R. Polarity Therapy: The Complete Collected Works, Vol. 1. Sebastopol, CA.

CRCS Publications. 1986.

57. Stone, R. Polarity Therapy: The Complete Collected Works, Vol. 2. Sebastopol, CA. CRCS Publications. 1987.

58. Sutherland, WG. In Sutherland, AS and AL Wales (eds.). Contributions of Thought. Portland, OR. Rudra Press. 1998.

59. Tiller, WA. Science and Human Transformation: Subtle Energies, Intentionality, and Consciousness. Walnut Creek, CA. Pavior Publishing. 1997. p. 36.

60. Ibid. p. 23.

61. Trock, DH, Bollet, AJ, Dyer, RH, Fielding, LP, Miner, WK and R Markoll. A double blind trial of the clinical effects of pulsed electromagnetic fields in osteoarthritis. The Journal of Rheumatology. 1993. 20(3): 456-60.

62. Trowbridge, C. Andrew Taylor Still, 1828-1917. Kirksville, MO. The Thomas Jefferson University Press. 1991. p. 136.

63. Upledger, JE. Somatoemotional Release and Beyond. Palm Beach Gardens, FL. UI Publishing. 1990. pp. 35-37.

64. Ibid. pp. 61-85.

65. Upledger, JE and JD Vredevoogd. Craniosacral Therapy. Seattle. Eastland Press. 1983. pp. 74, 139-40, 164-66.

66. Ibid. pp. 7.

67. Upledger, JE. Beyond the Dura. Seattle. Eastland Press. 1987. pp. 212-14.

68. Ward, RC (ed.). Foundations for Osteopathic Medicine. Baltimore. Williams & Wilkins. 1997.

69. Osteopathic glossary. Ibid. p. 1138.

70. Zimmerman, J. Laying-on-of-hands healing and therapeutic touch: a testable theory. BEMI currents. Journal of the Bio-Electro-Magnetics Institute. 1990. 24: 8-17. □

Address correspondence to:

Jan T. Hendryx, DO
 Hendryx Wellness Centre
 9 Mechanic St
 Bradford, PA 16701
 Fax: 814/368-3559
 Email: jhendryx@penn.com

or

Richard L. O'Brien, DO
 2305 Genesee Street
 Utica, NY 13501
 Fax: 315/735-2641

**THREE BOOKS
 on One CD**

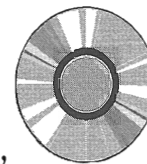

*Trilogy
 of Osteopathic Archives*

**Osteopathic Mechanics
 by Edythe F. Ashmore, DO**

**Applied Anatomy
 of the Lymphatics
 by F. P. Millard, DO**

**Intra-Pelvic Technic
 by Percy H. Woodall, MD, DO**

ONLY \$19.95

Name (please print)

Street Address

City, State, Zip

Daytime Phone

MasterCard or VISA

Card Number

Expiration Date

Signature

Item No. WPCD03

American Academy of Osteopathy
 3500 DePauw Blvd., Suite 1080
 Indianapolis, IN 46268
 Phone: 317/879-1881
 Fax: 317/879-0563

Facilitated Oscillatory Release – a method of dynamic assessment and treatment of Somatic Dysfunction

Zachary J. Comeaux DO, FAAO

Abstract

Facilitated Oscillatory Release (FOR) is a method for the dynamic manual application of oscillatory force organized to be useful in osteopathic diagnosis and treatment. It presumes the intimate familiarity of the osteopathic physician with the functional anatomy of the patient, and other traditional manipulative approaches. The goal is entrainment of the proprioceptive coordination process of the body to reset to a neutral state after strain or trauma. FOR does this by engaging the body's own rhythmic neural coding process.

This method relies on the neurophysiologic constructs of resonant cell assemblies and sync fire chaining along with signal phase coherence patterns, to describe integrated coordination of muscle control at and above the cord level. These concepts help explain the more specific mechanisms involved in the alpha-gamma phasic resonant coactivation and their role in recruitment of muscle fiber groups in maintaining hypertonus, alluded to but not elaborated in CounterStrain and Muscle Energy theory.^{1,2}

The FOR method uses the practitioner's sense of tissue dynamics in order to make a diagnosis and to execute a specifically focused application of restorative force. Tissue is handled as a participant in wave mechanics. Implications for neuro-

physiologic entrainment are described. Common structural diagnosis and treatment strategies are included along with their principles of efficacy. Since all osteopathic technique works with the body's own mechanisms, the examples are given in such a way that the principles may be implemented in the context of the practitioner's preferred techniques where possible.

Introduction

The intention of osteopathic manual contact has always been to maximize the body's harmonious structural and functional balance. Actually, the pursuit of further understanding and efficiency in osteopathic treatment rests on a progressive understanding of the interrelationship of structure and function in the nature of the person, our patient. Past advances in technique have largely been empirically derived, from insightful observations of symptom response to an intended or unintended intervention followed by physiologically oriented reflection to explain the effectiveness of the technique.

Facilitated Oscillatory Release (FOR) is derived from two directions of intentional exploration. One is the desire to apply more simply Robert Fulford DO's vibratory method of treatment without the dependence on the percussor. The second is the intention to intervene in dysfunction

using the body's own patterns of oscillatory organization. I have briefly referred to this latter topic in the review article, "The Role of Vibration or Oscillation in the Development of Osteopathic Thought", in the Fall 2000 issue of the *AAOJ*.³ In the present article, I will introduce FOR as a method of diagnosis and treatment, and spend more time introducing aspect of neuroscience that the osteopathic community should find of interest in further understanding somatic dysfunction in general, beyond the specific needs this method.

For those not familiar, Dr. Fulford's contribution to osteopathic manipulative work was to further advance Sutherland's appreciation of the fine coordinative processes of the body and their manual appreciation. He felt that dysfunction, especially chronic dysfunction, depended on the residue of a traumatic event retained in the fascial tissue partly on the level of chemical retention of fibrin bonds, but partly through a quantum physics level continuity, which classically had been understood as the etheric body.

One of his more easily taught methods of releasing the patient for the effects of such trauma was the use of the percussion vibrator. The Freedom Percussor or "hammer" was used to entrain through vibration "energy sinks", or tissue areas nonresponsive to the normal physiologic demand for motion. He perceived

these partly by sensing lack of resonance. Such effects could involve subsequent articular or regional restriction of motion, but many times the symptom involved a root cause of restriction in the energy, (etheric or L-field). Fulford taught several other methods reliant on hand and mind contact. However, my attempts here are aimed at allowing application of the principles for those who are most comfortable working primarily with the physical aspect of the body.⁴

Working under Doctor's (Fulford) tutelage, I would not consistently have the same experience on palpating the patient as did the Doctor. However, I would consistently feel muscle tension and release corresponding to the quality and timing of events he would describe. I wished to look for a more universal way to describe these events. As I would work, I found manual oscillation to complement a myofascial approach to dysfunction. As I progressed in this exploration, I would use it to complement my approach to the barrier in muscle energy work.

Reviewing and exploring in the medical literature, I became acquainted with the phenomenon of the tonic vibratory reflex. Long known in the field of muscle physiology, just as were the Hoffman or H-reflex and the stretch reflex, this awaited a clinical application. The tonic vibratory reflex is a phenomenon that is variously described. When an arm muscle belly is vibrated at the appropriate frequency, (40-100Hz), the subject loses a sense of where the limb is in space, the muscle or its antagonist muscle contract in a non-voluntary way, and a sense of motion occurs often in the absence of displacement.^{5,6,7,8} Further work in a cat model demonstrates that the reflex organization is distinct from other pathways but involves the gamma motor system.⁹

Further neural models explained below will suggest a practical asso-

ciation of these phenomena with other aspects of contemporary neuromuscular physiology. For now let me say that the tonic vibratory reflex leads to muscle relaxation, implementing a readjustment of gamma gain. It works in the range of frequency used by Dr. Fulford (up to 65 Hz), and relies on oscillatory depolarization of associated neuromuscular tracks in phase coherent patterns.

Theory

What do I mean by this phase, coherent patterns? These terms introduce us to the functional side of what we all know as the final common pathway in muscle activation. Frank Willard, PhD has reviewed recent theory with regard to segmental modulation of pain and hypertonia and their influence on base motor tone at the central or spinal level at many AAO educational symposia. The anatomic specificity of pathways supporting the hypothesis of facilitation, hyperexcitability of afferent/efferent loops by sympathetic input is dependent on descriptive circuitry. This represents a refinement on our appreciation of the pertinent anatomy, the structure, and of certain aspects of function.

A further appreciation of the functional aspect of motor activation and the response to stress comes from another area of neurophysiology. In working out the problem of specificity in coding and binding in the central nervous system (the way in which sensory stimuli are discriminated and stored), theorist noted that specific cell populations can be involved in the processing of various stimuli; sometimes individual cells could participate in several processes simultaneously. The patterns of depolarization, rather than exclusively the locus or synaptic pathway, emerge as significant in stimulus recognition. Beginning with Hebb's work in the 1940s, researchers describe the resonant depolarization of groups of cells, cell assemblies, their oscillatory de-

polarization, and the persistence of the coherence phase synchrony of these patterns, that constitute an event in the CNS, a stimulus recognition, a memory, an association.^{10,11,12,13}

Others have noted this function also in the PNS, in the spine (Windhorst) and so the body records pain and responses with hypertonus not simply with the continual discharge of a synaptic pathway, but through the pattern of cyclic depolarization within a population of cells (cell assembly). The relationship of phase coincidence and variation, or coherence, provides a code by which the body regulates activity. Threshold for activation of a function is dependent on coherence or resonance of cells linearly related in a chain (sync-fire chain) as the means of communication.^{14,15,16}

Phase synchrony or total coherence is equivalent in auditory experience to sounds being of the same pitch. In our sensual experience sounds slightly off pitch generate a beat frequency between the two notes. Sounds too far off pitch are perceived as noise, with no harmonic relationship to the original sound. Sounds at resonant intervals at an octave above or below again have a harmonic relationship to the first sound. What is proposed in the newer view of resonant cell assembly interaction is that oscillatory depolarization generated in response to a stimulus dominates neural function until one of disharmonic character arises to "swamp" the original pattern. Any circuit, including the Alpha-gamma system and their afferents will maintain a depolarization pattern until induced by new inputs to change that pattern.¹⁷

This activity continues below the level of the threshold of activation of muscle to gross contraction. There is extensive but diversely distributed literature on this work, but the most impressively applicable I have found



comes from a Swiss rehabilitative research physician, Giseler Schalow, who, in partial cord transected patients requiring other surgery, has monitored the activity of single pairs of contralateral (Left leg – right leg) distributed motor neurons. The state of paresis demonstrated one pattern of phase relationship in firing differing from that in normal function. After application of a repetitive oscillatory input to the distal extremity, (patient supported by a harness and bouncing on a trampoline, the subjects show progressive normalization pattern of firing in oscillatory phase between the neurons reapproximating normal functional pattern, and this coincides with progressive return of motor control and independent gait to the subjects.^{18,19}

Most of our somatic dysfunction does not represent the same extreme case, but I believe the principles apply.

Application

Having risked losing you to the theory of the omnipresence and significance of bioregulatory oscillation even in the musculoskeletal system, which can involve some serious reading, let me introduce you to the practical application of the method.

Dynamic Motion Testing and Treatment Strategies: an overview

The diagnostic method described predisposes a palpable dynamic aspect of tissue function as an extension of our usual static appreciation of tissue texture and incremental motion testing. Dynamic assessment can give a higher level of information about the body's integrated proprioceptive status.

Rhythmic motion, not just motion, seems to be integral to life. Babies rock spontaneously; rhythmic dance is part of all cultures. If one is a walker, or a runner, or a biker, one appreciates that these states of activ-

ity represent a base state against which one can judge change in function. While running one may note a favoring one aspect of stride, imbalance of gait cycle, the effect of fatigue and compensation for these. One cannot easily assess rhythmic function in a patient by chasing them as they walk or run to try to palpate this higher level of proprioceptive organization. However, I have found useful ways to induce rhythmic motion. In doing so, we consider the linear arrays of connective tissues, on several organizational levels, to be capable of transmitting force as a rope transmits force in wave form, in ways that can be anticipated. Variations from the anticipated pattern reflect dysfunction.

Wave Physics and Tissue

Response to motion challenge

Reviewing basic wave physics, a rhythmically shaken rope behaves in a predictable fashion. If one end is fixed, some force is transmitted to the fixed attachment and some creates a reflected wave. If a system where both ends are fixed, a standing wave may arise which may also dissipates force through sound, such as in a guitar string. The behavior of the wave pattern in a string can allow us to deduce whether it is affected by an attachment at one end or two. Muscles act as potential transmitters of wave force, attached at both ends, origin and insertion.

When two forces, transmitted in a medium as waves, encounter on another there is the summation of the two. If the displacement of the medium is in the same direction the resultant wave shows an additive peak. If there is displacement in opposing directions, the waves cancel one another out to some extent and there is a wave less than one would expect from the operation of one wave alone.

One special case of summation is dampening, then the anticipated resonance is less than one expects because

of an unanticipated third contact absorbing force. Any third attachment or contact will act to distract force, limiting potential vibration, described as dampening the finger on the guitar string. If I introduce oscillatory motion into a system, I should be able to anticipate a response. And this is the basis for dynamical motion testing.

If one taps a glass, one expects a tone depending on the quality of the glass and fluid level. If one doesn't get the tone expected, maybe some outside influence is dampening the resonant response.

Application to the Body

With these principles in mind, consider the response to introducing rhythmic oscillatory motion in a body member, a limb or paraspinous tissue, and the potential for assessing restriction of motion (dysfunction) by noting any alteration from the expected response, or resonance. By inducing organized, standardized rhythmic motion, many conclusions about the degree and location of gross or subtle dysfunction of tissue can be identified.

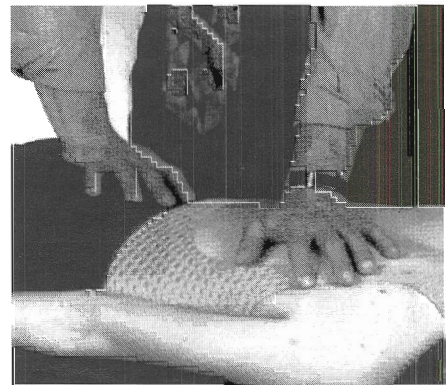

How does this translate into a protocol for assessment of spinal segmental function, a staple area for osteopathic work? I position the patient prone, which flattens out much of the postural curve. Standing on the patient's left, I use my hands to induce rhythmic oscillatory motion into the torso. Using the mass of the pelvis to begin oscillatory motion with my right hand resting on the sacrum

or ileum to develop a rhythmic cadence. The endogenous rhythmic character of this region usually allows 200-240 cycle per minute to feel resonant. I monitor the response in the tissue with my left hand anywhere on the right side of the spine that I choose to assess.

If I compare the response from segment to segment making a linear connection between the tissue mass engaged under the left hand and segmental contact with the hypothenar eminence of the right hand, I can feel which segments do not participate so easily in the harmonic motion pattern. I can infer dampening or other interference from hypertonic musculature, ligamentous articular tension, fibrosis, all of which ideally should be responding in a general rhythmic pattern.

Once I establish a standing wave, I can use this left hand to introduce it's own motion either complementing the existing standing wave created by the tissues response to my introduced motion (a basis for indirect technique). Or I can use the right hand to go 180 degrees out of phase with the pelvic motion (a basis for direct technique). This introduction of corrective force then confronts or reinforces the momentum of the dominant rhythmic pattern of the tissues, which, in dysfunction, is not representing a homeostatic optimum condition.

Key to treatment

Motion is life. Revitalization, or return to higher function, results from rhythmic entrainment of the resistant tissue. If one exaggerates the direction of restriction of the segment (T6 will not so easily left rotate) on provides an oscillatory treatment. If one exaggerates in a direction to resist the direction of ease of the segment involved, one is providing a direct oscillatory treatment. Other methods of osteopathic manipulation are interpreted as decreasing the dampening of endogenous rhythmicity by other means,

mechanical or neurofunctional.

The premise of the method is that the gross tissue character follows from the microscopic structure and function, which communicates through a pattern of oscillatory organizational function, and is liable to entrainment by a resonant or near resonant oscillatory function, even if extraneously introduced. Connective tissue has the capacity to generate a minute electric potential in response to stress. In dry bone specimens this is called piezoelectricity; in living wet tissue these are called streaming potentials. The work with tonic vibratory effects on the gamma system of proprioceptive muscle tone also suggests that these potentials are liable to being influenced by oscillatory input and that the associated signals from the spindle fibers themselves translate into changes in base-line muscle tension. In this work rhythm or phase coherence, not amplitude of force or mechanical displacement, is the key feature of effective corrective force. The mechanical aspect is important in supporting oscillatory function, just as the neck and tuning pegs of a guitar are essential. However, the operative principles in harmony are of another order.

Application in the limbs – lower extremity

The above cited regional and segmental procedure can be extended to diagnosing and treating in the ex-

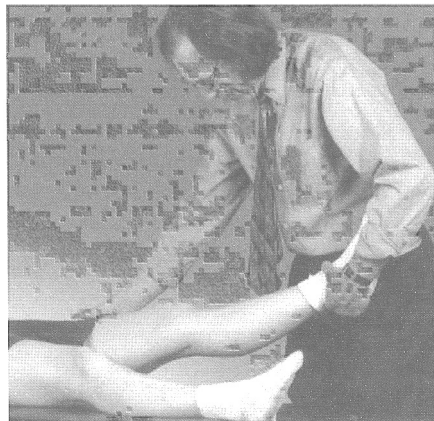

tremities. The lower limb is easier to model and will be used as an example.

Approaching the supine patient from the foot, I support the right leg in both hands gentle an inch or two above the table. Introducing gentle traction to put the fascia under tension, focusing my attention, I can sense fascial connectedness up into the pelvis using the leg as a long lever. Introducing gentle oscillatory force in a horizontal or vertical plane, I can assess response reflecting relative resonant responsiveness, and if resistance is found, isolate it by changing the vector of tension, including external or internal rotation. As noted above, if one encounters relative resistance, tissue relaxation may be facilitated by engaging it, and introducing a persistent oscillatory stretch against this resistance. Initially, I will assess at about 180 cycles per minute, whatever the endogenous tissue will support, for just 8 to 10 cycles for assessment.

To work more directly with the pelvis, I lift the heel in both hands to my waist height, introduce internal or external rotation to engage the intended treatment target, and introduce a horizontal oscillatory force, at the endogenous rhythmic rate until release occurs. I may assess this by increasing torsion during oscillation or, I may pause to reassess in a quieter mode. All this can be done very quickly and efficiently as one moves through the region by changing hand contact or vectors. One can shorten up one's grip between points of contact for more localized assessment as I have described below in the upper extremity.

Hopefully one begins, as one reads, to see that the goal is to promote tissue relaxation, enhancing connective tissue hysteresis, through rhythmic motion. The principles of the method may be used in any setting in which connective tissue stretch is an element of the treatment. Muscle and connective tissue represent a syncytial continuum.



Methods of impacting them use common principles and so methods can be easily eclectically combined.

Upper extremity

In the upper extremity, the range of motion is more complex and the potential for restriction follows suit. Dynamic assessment must be readjusted according to one's intent.



In seated or supine position, one can evaluate the total limb and its attachment to the trunk using the arm as a long lever as indicated in the section above, grasping with both hands at the wrist. By varying positions of grasp and the tension and direction, one can assess the longitudinal fascia of the arm, the periscapular tissue, rotator cuff of pectoral musculature and clavicle. By separating the hand contact, one can assess a subset of the region and explore more anatomically specific tissues, the forearm, and elbow flexors, individual rotator cuff muscles. Once resistance is identified using connective tissue cues, an oscillatory strategy is initiated, working with the tissues endogenous rhythmicity, to induce greater mobility.

Clinically, I use this approach as part of my treatment to overuse syndromes involving partial brachial plexus compression by a complex of

tissues, "frozen shoulder", carpal tunnel compression. A gentle oscillatory rotational motion is coupled with balanced ligamentous tension technique for interphalangeal joint synovitis after compression of "jamming" a finger.

Cervical, Cranial Applications

In a relaxed supine patient position, one can apply these techniques in the cervical and cranial area. In this approach, the position of the hands is intent on providing a relaxed and comfortable position for the patient, and localization of forces by the physician depending on your intention to a direct or indirect approach. These principles can be interpreted to fit as an addition to a muscle energy, connective tissue, function or ligamentous articular release approach. Once one has localized forces to assess, then treat with gentle oscillatory force as a fluttering rotation of the operator's wrist, one can introduce sufficient rhythmic force to assess

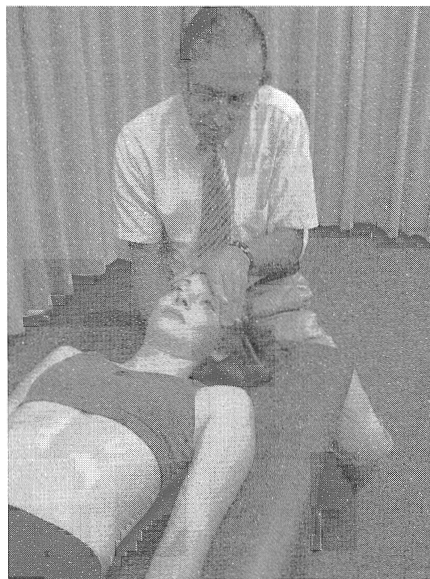

resonance and promote rhythmic response. As relaxation is achieved, the set up can be advanced to engage further resistance at the discretion of the operator.

In cranial work this adjunct is most useful if one is concentrating on engagement of membranous-articular

restriction. The same principles apply and one engages an identified restriction of function or motion, localizing in whatever manner is customary, and introduces the rhythmic os-

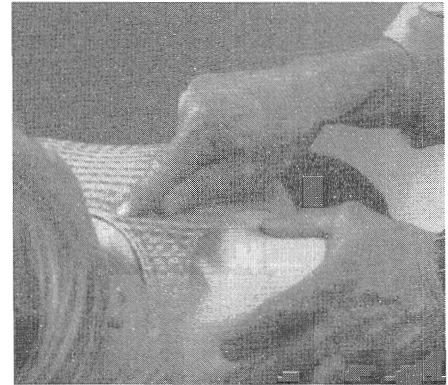

cillatory motion through one of the hands of the hold. The motion is a gentle, inductive, and facilitory flutter. The amplitude of oscillation is an inch of wrist rotation at 400-450 cpm.

Focal Application

For applications in inhibiting or softening tissue at a very focal location such as in irritated intercostals muscle, or rectus capitus near the OA joint, or tightness in the iliotibial band insertion at the knee, I will use a braced index finger to apply a rapid, focused vibratory force using my forearm to generate the smooth momentum for continued oscillation.

Summary

The above is a description of a method of discovering, engaging and releasing restrictive dysfunction on the body's own terms. Successful manipulation has always represented a dialogue with the tissues. A significant amount of scientific evidence is mounting to identify the dynamic coordinative processes the body uses, especially in neuronal and neuromuscular function.

Facilitated Oscillatory Release is an approach which tries to understand and communicate with the body under strain in response to trauma, using it's

own coordinative language of oscillatory rhythmicity. It represents a blending of principles derived from Fulford's Percussive Vibration model, Connective Tissue Release, Muscle Energy and several older methods.

The method represents a different way to think about existing methods and a bridge to a organizing more functional, dynamic expansion of our mechanical models and methods.

References

1. Jones, L. 1995. *Jones Strain CounterStrain, 2nd ed.* Jones Strain-CounterStrain Inc. Boise Idaho. pp. 13-15.
2. Mitchell, F. 1995. *The Muscle Energy manual, vol. 1.* MET Press. East Lansing Michigan. pp. 9-11.
3. Comeaux, Z. The Role of Vibration or Oscillation in the Development of Osteopathic Thought. *American Academy of Osteopathy Journal.* Fall 2000. 10:3:19-24.
4. Comeaux, Z. *Twentieth Century Medicine: the life and work of Robert Fulford, DO.* Eastland Press.
5. Roll, JP and Gilhodes, JC. 1995. Proprioceptive Sensory codes mediating movement trajectory perception: human hand vibration-induced drawing illusions. *Can. J. Physiol. Pharmacol.* 73:295-304.
6. Gilhodes, JC, Gurfinkle, VS, Roll, JP. 1992. Role of Ia muscle spindle afferents in post-contraction and post-vibration motor effect genesis. *Neuroscience Letters.* 135:247-251.
7. Burke, D, Hagnbarth, KE. 1976. The Responses of human muscle spindle endings to vibration during isometric contraction. *J. Physiol.* 261:695-711.
8. Prochazka, A, Trend, PSJ. 1988. Instability in human forearm movement studied with feed-back-controlled muscle vibration. *J. Physiol.* 402:421-442.
9. Smith, J, Bradley, N. 1986. *Rhythmical movements of the hindlimbs in spinal cat: considerations for a controlling network in Development and Plasticity of the mammalian Spinal Cord.* Goldberger, E, Gorio, A. eds. Livonia Press. Padova.
10. Fujii, H. 1996. Dynamical Cell Assembly Hypothesis – Theoretical Possibility of Spatio-temporal Coding in the Cortex Neural Networks, *Neural Networks,* 9:8:1303-1350.
11. Valera, F. 1995. Resonant Cell Assemblies: A new approach to cognitive functions and neuronal synchrony. *Biol. Res.* 28:81-95.
12. Spatz, H.C. 1996. Hebb's concept of synaptic plasticity and neuronal cell assemblies. *Behavioral Brain Research.* 78: 3-7.
13. Sakurai, Y. 1996. Population Coding by call assemblies – what really is in the brain. *Neuroscience Res.* 26:1-16.
14. Windhorst, U. 1988. How Brain Like is the Spinal Cord? Interacting Cell assemblies in the nervous System. Springer Verlag.
15. Windhorst, U. 1996. The Spinal Cord and Its Brain: Representations and models to what extent do forebrain mechanisms appear at brainstem spinal cord levels. *Progress in Neurobiology.* 49: 381-414.
16. Farmer, S. 1998. Rhythmicity, synchronization and binding in human and primate motor systems. *J. Physiol.* 509:1:3-14.
17. Zedka, M. 1997. Phasic Activity in the human erector spinae during repetitive hand motions. *J. Physiol.* 504:3:727-734.
18. Schalow, G. 1993. Spinal Oscillators in Man under normal and pathological conditions. *Electromyog. Clin. Neurophysio.* 33:409-426.
19. Schalow, G. Zach, G. 1998. Neuronal Reorganization through Oscillator Formation Training in Patients with CNS Lesions, *J. of the Peripheral Nervous System,* 3:3: 165-188. □

Address correspondence to:
Zachary J. Comeaux, DO, FAAO
Associate Professor/Section of OPP
West Virginia School
of Osteopathic Medicine
400 N. Lee Street
Lewisburg, WV 24901
Fax: 304/645-4859
E-mail: zcomeaux@wvsom.edu

2004 Annual Convocation

American Academy of Osteopathy

The Application of Osteopathic Principles in the Management of Chronic Disease

Jane E. Carreiro, DO, Program Chairperson

March 17-21, 2004

The Broadmoor Hotel
Colorado Springs, CO

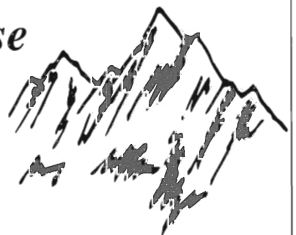

American Academy of
Osteopathy
3500 DePauw Blvd.,
Suite 1080
Indianapolis, IN 46268
Phone: 317/879-1881
Fax: 317/879-0563

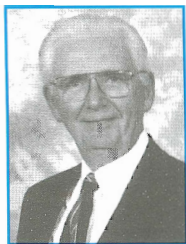

Diagnosis of Muscle Imbalance and Exercise Prescription

(The Greenman Protocol)

Philip Greenman, DO, FAAO
Featured Speaker
Author of *Principles of Manual Medicine*

AZCOM, Glendale, AZ
January 23-25, 2004

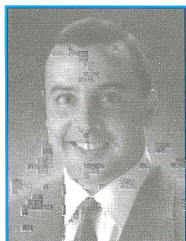

Brad S. Sandler, DO,
Program Chair

The program anticipates being approved for 20 hours of AOA Category 1-A CME credit pending approval by the AOA CCME.

COURSE DESCRIPTION: LEVEL II

How to access muscle balance of the musculoskeletal system, particularly in reference to somatic dysfunction. The primary goal is to prescribe an exercise program and self-mobilization techniques to fit the patient's somatic dysfunction in order for the patient to manage themselves.

LEARNING OBJECTIVES:

1. To understand the functional anatomical connections of upper and lower quarter musculature to the proximal trunk and pelvis.
2. To introduce the concept of neuromuscular imbalance as a contribution to chronic musculoskeletal dysfunction.
3. To learn exercises to address specific somatic dysfunctions found in the vertebral column and pelvis.
4. To be able to design and sequence a home exercise program for patients to complement manual medicine.
5. To be able to instruct the patient in an exercise program based upon his/her functional goals and life-style.

PREREQUISITES: Functional Anatomy; One Level I course or equivalent

PROGRAM TIME TABLE:

Friday, January 23 8:00 am - 5:30 pm
 Saturday, January 24 8:00 am - 5:30 pm
 Sunday, January 25 8:00 am - 12:30 pm
 (Friday & Saturday include (2) 15 minute breaks and a (1) hour lunch;
 Sunday includes a 30 minute break.)

COURSE LOCATION:

Midwestern University/Arizona College of Osteopathic Medicine
19777 N. 59th Avenue
Glendale, AZ 85308

HOTEL ACCOMMODATIONS:

For hotel possibilities, visit: www.hotels.com; www.expedia.com;
www.travelocity.com; www.priceline.com; or www.BizRate.com.

REGISTRATION FORM
Diagnosis of Muscle Imbalance and
Exercise Prescription
January 23-25, 2004

Full Name _____
 Nickname for Badge _____
 Street Address _____

 City _____ State _____ Zip _____
 Office phone # _____ Fax #: _____
 E-mail: _____
 AOA # _____ College/Yr Graduated _____
 I need AAFP credit
(AAO makes every attempt to provide snacks/meals that will meet participant's needs. However, we cannot guarantee to satisfy all requests.)

	REGISTRATION RATES	
	ON OR BEFORE 12/23/03	AFTER 12/23/03
AAO Member	\$550	\$650
Intern/Resident/Student	\$450	\$550
AAO Non-Member	\$755	\$855

(Non-members – see membership application on page 23)

AAO accepts Visa or Mastercard

Credit Card # _____
 Cardholder's Name _____
 Date of Expiration _____
 Signature _____

Reviewer: Nancy Vitucci

New book traces osteopathic philosophy's ties to modern science

When James J. McGovern, PhD, and Rene McGovern, PhD, began researching their book, *Your Healer Within—A Unified Field Theory for Healthcare*, they did not have to go far.

As the president of the A.T. Still University of Health Sciences and as an associate professor of neurobehavioral science at the university's Kirksville College of Osteopathic Medicine (KCOM), respectively, Drs James and Rene McGovern made full use of the Still National Osteopathic Museum, which is located on the university's campus.

The museum's collection of books about Andrew Taylor Still, MD, DO, articles written by Dr Still, and his handwritten materials became important research tools for the married authors.

Your Healer Within explores the body's innate ability to heal itself and probes whether there is a relationship between the philosophy of osteopathic medicine and the findings of modern science. The book also discusses how the mind, body and spirit tenet of osteopathic medicine is found in many different cultures, including Asian, Muslim and Buddhist.

Seeking inspiration

In the book, the Drs McGovern report that Dr Still was inspired by three scientists from the 1800s: Louis Pasteur, Charles Darwin and Rudolph Virchow. According to the authors, Dr Still drew upon the philosophies of these scientists in developing the three key principles of osteopathic medicine: the unity of mind, body and spirit; the interrelationship between structure and function; and the body's ability to heal itself.

"From studying these visionaries, Dr Still realized that nature is constantly trying to perfect the body, which can heal itself," says Dr James McGovern, who holds degrees in physics, mathematics and natural sciences.

Was a connection proved

Throughout their book, the Drs McGovern try to show a connection between the philosophy of osteopathic medicine and the philosophies underpinning other approaches to medicine.

Thomas Wesley Allen, DO, believes the authors succeeded in that task.

"In an interesting way, the book connects the history of medicine to the philosophy of osteopathic medicine," says Dr Allen, the immediate past vice president for health affairs and dean of the Oklahoma State University College of Osteopathic Medicine in Tulsa. "Dr Still borrowed from ancient philosophies and medicines. Through research, the authors demonstrate how we can find the teachings of osteopathic medicine in other fields of medicine.

"Readers of the book will gain insight into our profession's history."

Arnold Melnick, DO, however, is not convinced that the authors showed a connection between Dr Still's philosophies and other medical traditions.

"In reading the book, I found that some theories seemed unsubstantiated," contends Dr Melnick, the founding dean of the Nova Southeastern University College of Osteopathic Medicine in Davie, Fla. "Many of the sources on osteopathic medicine cited in the book are not those normally cited in our profession's literature, so I began questioning the data and what the authors were trying to say. In contrast, Irvin M. Korr, PhD, received very little play in the book even though he is a highly regarded researcher who studied the physiology of osteopathic medicine and osteopathic manipulative treatment at KCOM and two other osteopathic medical colleges.

"Readers must be able to understand where the authors' thinking is leading—even if they don't necessarily agree. I couldn't do that with this book."

Who's your audience?

While they disagree on how successfully *Your Healer Within* accomplishes some of its goals, Dr Allen and Dr Melnick agree that the book could be of value to the osteopathic medical profession.

"The book could be a rich resource to facilitate teaching the history of medicine at our schools," suggests Dr Allen, a former editor in chief of the AOA and a former member of the AOA Committee on Osteopathic History. "Faculty

members should use the book to strengthen their curricula.”

Dr Melnick believes that DOs could find value in reading the book, but he warns that they should not expect a history of the profession.

“The book isn’t specifically about osteopathic medicine but rather is a philosophical look at the history of medicine,” says Dr Melnick, who retired from Nova Southeastern in 1998 as the executive vice chancellor and provost of its Health Professions Division.

Where to find Your Healer

Your Healer Within, which was published in May by Fenestra Books, is available online at www.amazon.com and www.barnesandnoble.com. The book is also available at KCOM’s bookstore.

In addition, the book is being sold at the Smithsonian Institution, where A.T. Still University’s traveling exhibit, *The Healer Within*, is on display until Sept 2.

Reprinted from *THE DO*, an official publication of the American Osteopathic Association, August 2003, vol. 44, No. 8, page 51

Manipulation At Home: Exercises Based On Osteopathic Structural Exam

Manipulation At Home: Exercises Based On Osteopathic Structural Exam by **David R. Essig-Beatty, DO** is the first book to compile four types of exercises derived from osteopathic manipulative treatment. Positions of ease, myofascial stretches, joint mobilizations, and postural strengthening exercises are provided as single page handouts with clear descriptions and black and white illustrations for ease of photocopying. Written for manual medicine practitioners, *Manipulation At Home* includes literature reviews of manipulation and exercises for common clinical problems. Concise descriptions of exam skills are accompanied by clear line drawings and black and white photographs. 299 pages, 80 exercise handouts, 32 problem routines, soft cover, spiral bound, \$36. Available now at the West Virginia School of Osteopathic Medicine Bookstore by calling 1 800 356-7836 ext. 259 or by e-mailing cknight@wvsom.edu

Dr. Essig-Beatty, associate professor of Osteopathic Manipulative Medicine/Family Medicine at WVSOM, has worked 20 years in compiling material for his book. He first realized the need for literature on this subject matter when he was in medical school and determined that no manual had ever been made that discussed proper manipulative procedures for patients to perform on themselves. (Source: WVSOM News Release)

Reprinted from the West Virginia School of Osteopathic Medicine website, Bookstore

Osteopathic Approach to Gastroenterology

(Visceral Technique)

Jean-Pierre Barral, DO, MROF will be returning in 2005.

**Pre-requisite to attend Dr. Barral’s course is at least (2) visceral manipulation
AAO courses taught by Kenneth Lossing, DO.**

Colorado Springs, CO
March 15-17, 2004

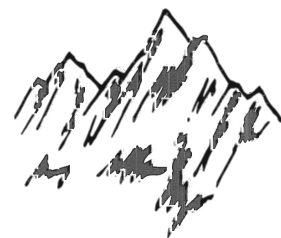

COURSE DESCRIPTION: LEVEL III

In this course the role of visceral dysfunction in various gastroenterology diseases is explored. We follow traditional osteopathic thought of looking at the whole body, along with the specific area of symptoms. Principles originating with Dr. Still, along with many of his students, are incorporated, along with principles and approaches from Barral. Medical diagnosis of GERD, dyspepsia hiatal hernia, peptic ulcers, cholestasis, chronic hepatitis, irritable bowel syndrome, and constipation, along with associated musculoskeletal disorders will be covered.

American Academy of Osteopathy
3500 DePauw Blvd., Suite 1080
Indianapolis, IN 46268
Phone: 317/879-1881
Fax: 317/879-0563

PALPATION OF SKELETAL MUSCLES: A PSYCHOMETRIC EVALUATION OF THE MUSCULAR ITEMS OF THE COMPREHENSIVE BODY EXAMINATION.

Journal of Musculoskeletal Pain, Vol. 11(1) 2003, 21-30.

Bunkan BH, Opjordsmoen S, Moen O, Ljunggren AE, Friis S.

ABSTRACT. Objectives: The present study aims at evaluating the psychometric properties of a palpatory examination of skeletal muscles.

Methods: Fifty-one nonpatients (NP group), 17 Patients with Pain Syndromes (PSP group), 27 Patients with Psychosis (PP group) and four patients with nonpsychotic mental disorders were examined by palpation.

Results: Through factor analyses four subscales emerged: 1. Peripheral Slackness (PS), 2. Central Hardness (CH), 3. Peripheral Hardness (PH), and 4. Central Slackness (CS). The subscales showed high internal consistency (Chronbach's alpha: .72-.92) and were slightly to moderately intercorrelated. The PS, CH and CS subscales discriminated significantly between the NP and the PP groups. Compared with males, the females were characterized by more slack and less hard muscular consistency. No significant differences for any of the subscales emerged when comparing scores for patients with and without medication.

Conclusions: The new subscales will be relevant for physiotherapists, physicians, and psychologists who want to study the state of muscular consistency in individuals with various mental disorders.

Discussion. The authors of this paper consider that the concept of tone (measured by palpation) can be easily confused with the neurological definition of tone (measured by passive movements or electromyography). The questions which concern them are: What is actually being measured during palpation of muscular consistency? What degrees of hardness or slackness of muscular consistency imply pathology? These questions were focused on patients with mental illnesses. The authors utilized the Comprehensive Body Examination (CBE) based on their work with the Resource Oriented Body Examination (ROBE), comprising the domains of Posture, Respiration, Movements and Muscular Consistency. While the ROBE had been utilized to reveal degree of rigidity, changeability in body defences, and definition of intervention, the CBE aims at measuring the four body domains. The first author, the developer of the CBE, performed all body examinations. 14 pairs of bilateral muscles which were utilized included extremities, shoulders and back regions. The pairs of muscles included paralleled the central and peripheral dimensions of the group's study of Posture. Assessment of the muscles for hard and slack consistency provided a total of 56 ratings for each patient. Intercorrelation of scores between sides of the body resulted in the use of mean score for each muscle pair in calculation. Hard and slack muscular consistency is described as resistance to palpation, regardless of factors contributing to those characteristics. Ideal muscular consistency is interpreted as slight, springy resistance to pressure, with ease of manipulation. The middle of the muscle belly was usually palpated, in order to reduce the influence of intervening factors such as connective tissue distribution. Rating was done by : 1. Evaluation of the subcutis (gripping a skin fold of about 5 cm. and lifting to estimate thickness); 2. Localization of the actual muscle to be palpated; 3. Evaluation of size and homogeneity of the muscle performed by sliding movements across the muscle; 4. Assessing compliance (gripping the round muscle and pressing the fingers into the tissue of flat muscle). It was reported that a 2 kg. force was used to determine ease of indentation and springiness of muscle. The distance of compression in relation to thickness was utilized as the basis for recording muscular consistency. Compressions were limited to a maximum of 3 to 4. Each muscle's hardness or slackness was scored on a separate 7-point rating scales ranging from 0 to 6. □

ADDRESS SERVICE REQUESTED

Osteopathic Treatment of Headache

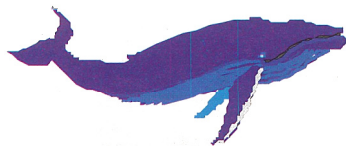

**Honolulu, Hawaii
February 13-16, 2004**

The program anticipates being approved for 20 hours of AOA Category 1-A CME credit pending approval by the AOA CCME.

DESCRIPTION:

Overview of the osteopathic treatment of headaches

OBJECTIVES:

- Review epidemiology and etiology of headache
- Review types of headache
- Review current osteopathic treatment of headache including indications and contraindications
- Review osteopathic diagnosis
- Review osteopathic manipulative treatment
- Review coding & billing implications

COURSE LOCATION:

Hilton Hawaiian Village Beach Resort & Spa
2005 Kalia Road
Honolulu, HI 96815
Phone: 808/949-4321
Website: www.hawaiianvillage.hilton.com

ROOM ACCOMMODATIONS: RANGE OF RATES:

Hilton Hawaiian Village \$185-\$495

*For optional hotel accommodations, visit:
www.hotels.com; For best rates during January, type in
Honolulu and appropriate dates.*

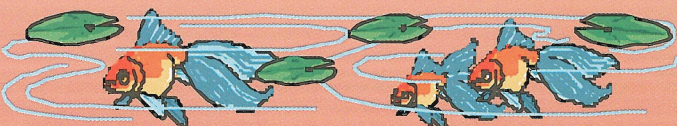

REGISTRATION FORM

Osteopathic Treatment of Headache

February 13-16, 2004

Full Name _____

Nickname for Badge _____

Street Address _____

City _____ State _____ Zip _____

Office phone # _____ Fax #: _____

E-mail: _____

AOA # _____ College/Yr Graduated _____

I need AAFP credit

(AAO makes every attempt to provide snacks/meals that will meet participant's needs. However, we cannot guarantee to satisfy all requests.)

REGISTRATION RATES

ON OR BEFORE 1/13/04 AFTER 1/13/04

AAO Member \$550 \$650

Intern/Resident/Student \$450 \$550

AAO Non-Member \$755 \$855

AAO accepts Visa or Mastercard

Credit Card # _____

Cardholder's Name _____

Date of Expiration _____

Signature _____